

Mako User's Manual



INDEPENDENT X-RAY
QUALITY ASSURANCE

RTI document 4765.002438

v2024.2A



NOTICE

RTI Group AB reserves all rights to make changes in the Ocean Next software, and the information in this document without prior notice.

RTI Group AB assumes no responsibility for any errors or consequential damage that may result from the use or misinterpretation of any information contained in this document.

Copyright ©2024 by RTI Group AB. All rights reserved.

Content of this document may not be reproduced for any other purpose than supporting the use of the product without prior permission from RTI Group AB.

BLUETOOTH is a trademark owned by Bluetooth SIG, Inc., USA

User Manual downloads

You can download the User Manual here:

www.rtigroup.com/downloads



Contact Information World-Wide

RTI Group AB

Flöjelbergsgatan 8 C
SE-431 37 MÖLNDAL
Sweden

Phone:

Int. +46 31 746 36 00

E-mail:

Sales: sales@rtigroup.com
Support: support@rtigroup.com
Service: service@rtigroup.com

Web site:

<http://www.rtigroup.com>

Contact Information United States

RTI Electronics Inc.

33 Jacksonville Road, Bldg. 1,
Towaco, NJ 07082,
USA

Phone:

800-222-7537 (Toll free)
Int +1-973-439-0242

Fax:

Int +1-973-439-0248

E-mail:

Sales: sales.us@rtigroup.com
Support: support.us@rtigroup.com
Service: service.us@rtigroup.com

Web site:

<http://www.rtigroup.com>



Intended Use of the Mako System

Together with probes and modules, the Mako System is intended to be used for independent service and quality control, including measurements of kerma, kerma rate, kVp, tube current, exposure time, luminance, illuminance, and dose area product, within limitations stated below.

When installed according to accompanying documents, the product is intended to be used together with all diagnostic X-ray equipment except for:

- *therapeutical X-ray sources.*
- *X-ray equipment with tube potential below 18 kV or above 160 kV.*
- *X-ray equipment on which the instrument cannot be mounted properly.*
- *specific types of X-ray equipment listed in the instructions for use or in additional information from the manufacturer.*

With the X-ray installation without patient present, the product is intended to be used:

- *for assessing the performance of the X-ray equipment.*
- *for evaluation of examination techniques and procedures.*
- *for service and maintenance of the X-ray equipment.*
- *for quality control of the X-ray equipment.*
- *for educational purposes, authority supervision etc.*

The product is intended to be used by hospital physicists, X-ray engineers, manufacturer's service teams, and other professionals with similar tasks and competencies. The operator needs training to be able to use the product as intended. This training can be achieved either by study of the manual, study of the built-in help function in measurement software or, on request, by a course ordered from the manufacturer.

The product is intended to be used inside X-ray rooms ready for clinical use and can safely be left switched on and in any measuring mode in the vicinity of patients.

The product is NOT intended to be used:

- *for direct control of diagnostic X-ray equipment performance during irradiation of a patient.*
- *so that patients or other unqualified persons can change settings of operating parameters during, immediately before, or after measurements.*
- *for any guidance to diagnosis of patients.*

Table of Contents

1. Mako System.....	8
1.1 Mako System Overview.....	8
1.2 The Mako Base Unit.....	9
1.2.1 Overview, Mako Base Unit.....	9
1.3 Probes.....	10
1.3.1 R/F Probe.....	10
1.3.2 Mammo Probe.....	10
1.3.3 Dental Probe.....	10
1.4 Modules.....	11
1.4.1 Ion Chamber Module.....	11
1.4.2 mAs Module.....	11
1.4.3 Legacy Module.....	11
2. Measuring with the Mako System.....	12
2.1 Launching Quick Check.....	12
2.2 Measuring with R/F probe.....	13
2.2.1 Measuring Radiography.....	13
2.2.2 Measuring Fluoroscopy.....	15
2.2.3 Measuring CT.....	16
2.2.4 Measuring Dental.....	18
2.2.5 Settings for the R/F Probe.....	18
2.3 Measuring with the Mammo Probe.....	18
2.3.1 Measuring Mammography.....	19
2.3.2 Measuring Tomographic Mammography.....	20
2.3.3 Measuring Mammography in Combo Mode (2D+3D).....	21
2.3.4 Measuring Scanning Mammography.....	21
2.3.5 Measuring mA and mAs.....	21
2.3.6 Measuring dose with additional probe.....	21
2.3.7 Measuring with an Ion Chamber.....	21
2.3.8 Settings for the Mammo Probe.....	21
2.4 Measuring with the Dental Probe.....	22
2.4.1 Measuring on Intraoral Dental.....	22
2.4.2 Measuring on Panoramic Dental.....	23
2.4.3 Measuring on Dental CBCT.....	24
2.5 Measuring mA and mAs.....	24



2.6	Measuring with Ion Chamber Module.....	26
2.6.1	Measuring with CT Ion Chamber	27
2.6.2	Measuring DAP	28
2.6.3	Measuring with Magna Ion Chamber.....	29
2.6.4	Measuring with non-RTI Ion Chambers	30
2.6.5	Settings for the Ion Chamber Module.....	30
2.7	Measuring with the Legacy Module	30
2.7.1	Measuring with the RTI Light Probe.....	30
2.7.2	Measuring with the CT Dose Profiler	33
2.7.3	Measuring with the RTI Dose Probe	36
2.7.4	Measuring with the RTI T20	38
2.7.5	Measuring with the RTI MAS-1	39
2.7.6	Measuring with the RTI MAS-2.....	39
2.7.7	Measuring with the RTI Test Point Cable.....	39
2.7.8	Settings for the Legacy Module.....	39
2.8	Meter Settings	39
2.8.1	General Settings (probe Settings explained below, for each probe type) ...	39
2.8.2	Probe Settings.....	40
2.8.3	Meter/Probe information.....	42
2.8.4	Base Unit information	43
2.9	Measurement Principles & Theory.....	43
2.9.1	Waveforms and Triggers.....	43
2.9.2	Integrated signal (dose, mAs, etc.)	44
2.9.3	Signal rate (dose rate, tube current, etc.).....	44
2.9.4	Tube voltage signal (kV, kVp).....	44
2.9.5	Measurement Principle for the Mako	45
3.	The Quick Check Display.....	46
3.1	Measurement Displays	46
3.1.1	Changing unit of measure.....	47
3.1.2	Changing Beam Quality/Calibration.....	47
3.2	Waveform window	48
3.2.1	Analyzing waveforms	48
3.3	Measurement grid.....	50
3.4	Quick Check Report.....	50
3.5	Quick Check Options	52
4.	Updating the Mako system.....	54

5.	<i>Charging the Base Unit</i>	55
6.	<i>Scheduled Calibration</i>	56
7.	<i>The Mako Stand</i>	56
8.	<i>Manufacturer's Declaration of Conformity</i>	57
8.1	<i>CE Declaration of Conformity</i>	57
8.2	<i>UKCA Declaration of conformity</i>	60
8.3	<i>FCC Certification</i>	63
8.4	<i>Waste Electrical and Electronic Equipment (WEEE)</i>	63

1. Mako System

1.1 Mako System Overview

The Mako system consists of a base unit, a range of probes and modules and the Ocean Next computer software.

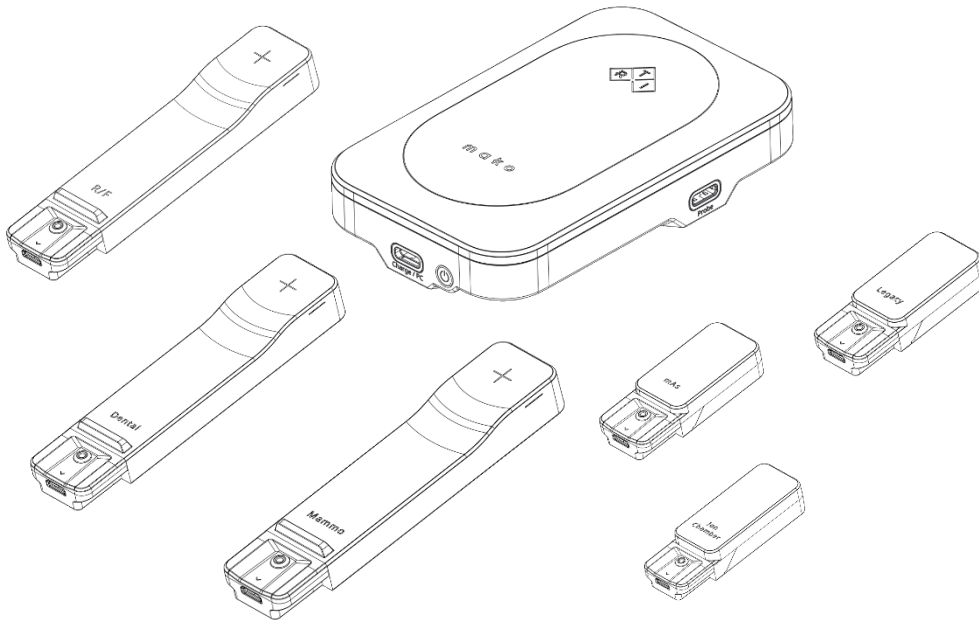

The Mako system can be used in two different ways:

- As an instrument with a Mako Display Device (such as laptop or tablet) with Quick Check
- As a complete QA-system with a PC and the Ocean Next templates

This manual describes the Mako system. The PC software, Ocean Next, is described separately.

The Mako system has three ports to which probes can be connected making it possible to measure several different values at the same time. E.g., typical parameters from the R/F Probe like kV, exposure, TF, HVL, Time etc in combination with mA, mAs and DAP which are measured using the appropriate modules. Connection and disconnection of probes is detected automatically, and the user is prompted to take suitable action depending on the new configuration.

The probe/module options are:

- R/F Probe, for radiography, fluoroscopy, CT and dental measurements
- Mammo Probe, for mammography measurements.
- Dental Probe, for dental X-ray measurements.
- Ion Chamber Module, for measurements using an ionization chamber e.g. CTDI applications or DAP measurements.
- mAs Module, for measuring tube current during exposure invasively or non-invasively.

- *Legacy Module, for measurements with existing RTI Probes such as*
 - *RTI Light probe, for illuminance measurements and luminance measurements on monitors and light boxes.*
 - *CT Dose Profiler for measurement of CT beam width or CTDI in one exposure*
 - *other probes that are used with Piranha and Cobia*

1.2 The Mako Base Unit

The Mako Base Unit is the power supply and communications hub of the Mako system.

To the Base Unit the user can connect one (1) probe at a time and/or one (1) module at a time. For some measurements situations, a combination of one probe and one module is possible, e.g. R/F Probe and mAs Module to simultaneously capture kV, dose rate, time and mA etc to analyze generator and tube performance.

1.2.1 Overview, Mako Base Unit

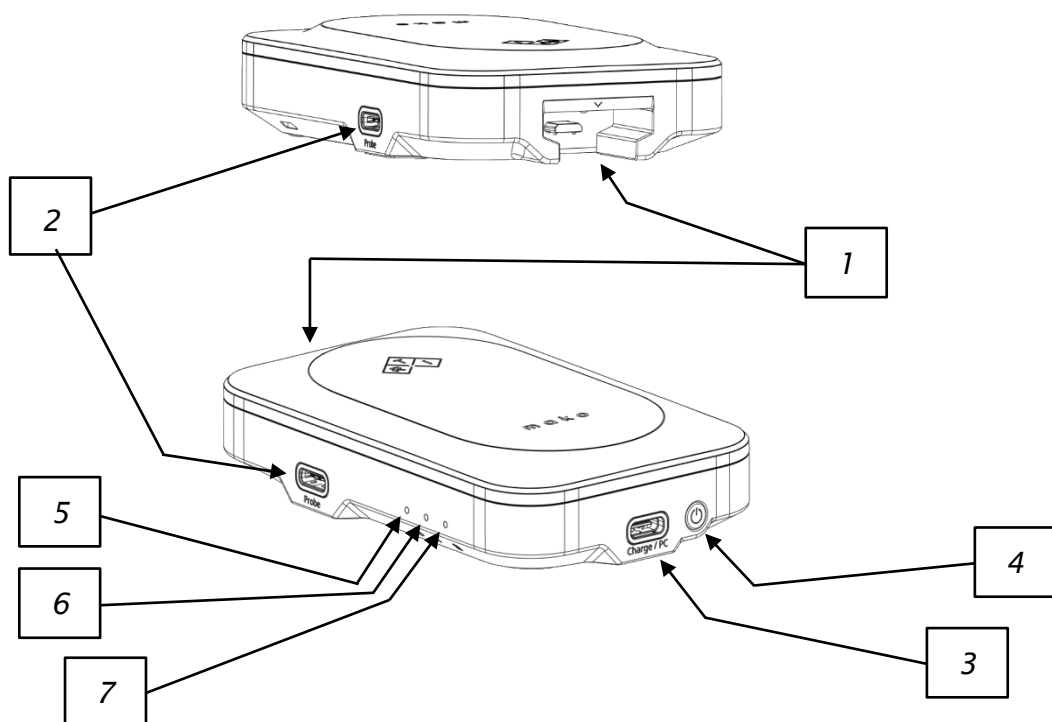

1. *Docking port for docked connection of probes or modules*
2. *USB-C ports for alternative connection of probes/modules*
3. *USB-C port for charging battery and communication to Ocean Display unit*
4. *On/off switch*



LEDs:

5. Status (green: system on, red: system error, dark: system off, slow flashing: sleep mode)
6. Bluetooth (flashing: Bluetooth searching, solid: connected, dark: USB is used)
7. Battery (solid orange: charging, flashing orange: low battery, dark: OK)

1.3 Probes

The 3 different probes, R/F Probe, Mammo Probe and Dental Probe all share the same form factor and basic detector design, with some important differences in configuration of filter layers and diode properties which are made to optimize performance in their respective modalities. The detectors are all backscatter protected so that only the incident air Kerma is registered.

The probes are connected either to the docking port or to one of the two USB-C ports using the provided standard USB-C/micro-USB cable.

1.3.1 R/F Probe

The R/F Probe is optimized for application in Radiography, Fluoroscopy, CT, Intraoral Dental, Panoramic Dental and Dental CBCT.

The multi-parameter R/F probe measures kVp, Exposure, Exposure rate, HVL, Total Filtration, Exposure time, Frame rate, number of frames/pulses and Exposure per frame.

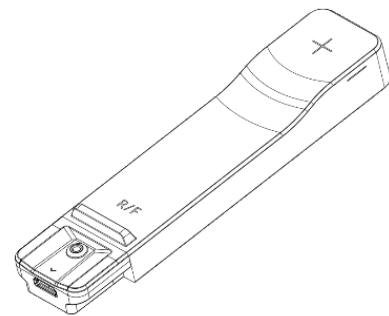

1.3.2 Mammo Probe

The Mammo Probe is designed for high accuracy measurement in Mammography machines.

The multi-parameter Mammo probe accurately measures Exposure, Exposure rate, HVL, and Exposure time regardless of what target/filter combination is selected. For precise kVp measurements, the user must select an appropriate target/filter combination.

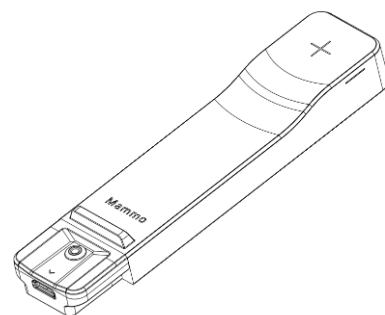

1.3.3 Dental Probe

The Dental probe is designed for measurement in Dental X-ray: Intraoral Dental, Panoramic Dental and Dental CBCT.

The multi-parameter Dental probe measures kVp, Exposure, Exposure rate, HVL, Total filtration, Exposure time and number of Pulses.

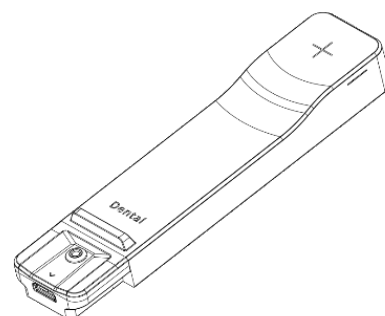

1.4 Modules

There are 3 different modules for the Mako system: the mAs Module, the Ion Chamber Module, and the Legacy Module.

The modules are connected either to the docking port or to one of the two USB-C ports using the provided standard USB-C/micro-USB cable.

Modules can be used either one at a time or in parallel with one probe.

1.4.1 Ion Chamber Module

The Ion Chamber Module is the electrometer and bias voltage supply for ion chambers.

It is compatible with all ion chambers supplied by RTI, that are equipped with a PID.

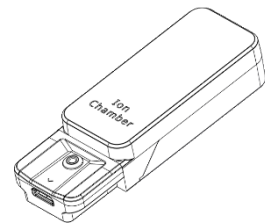

1.4.2 mAs Module

The mAs Module is used for mA/mAs measurements. The default cable is designed for invasive mAs measurement and connects to the mAs measurement sockets in the generator.

The optional MAS-2 cable is used for non-invasive measurement and connects to the MAS-2 clamp-on device.

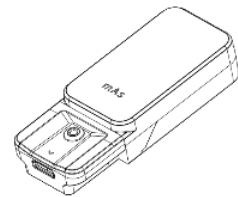

1.4.3 Legacy Module

The Legacy module is the interface for probes used in Piranha and/or Cobia systems: RTI Light probe, CT Dose Profiler, RTI Dose Probe, RTI T20 probe, RTI MAS-1 probe, and RTI MAS-2 probe.

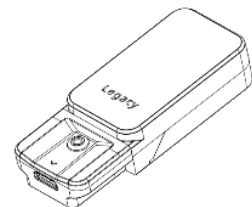



2. Measuring with the Mako System

2.1 Launching Quick Check

Turn the Mako Base Unit on by pressing the on/off button. The status LED will start flashing during start up and will shine with a steady green light when the system is ready. The flashing blue LED indicates that the Base Unit is ready to connect to an RTI display unit using Bluetooth.

Launch Ocean Next and click the Quick Check button (see image below) to start the Quick Check display.

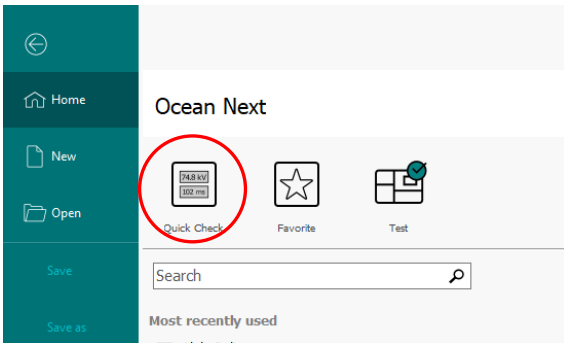

If you haven't connected a probe, or if the probe/module combination is not allowed, follow the instructions in the pop-up on the screen.

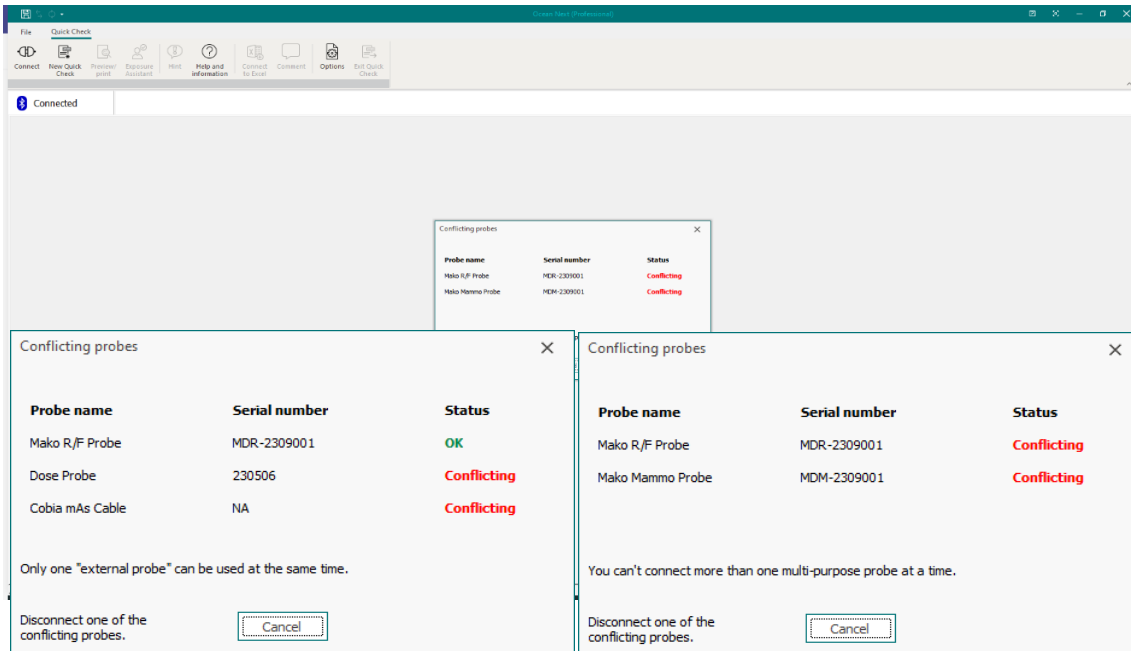

2.2 Measuring with R/F probe

With the R/F Probe connected, the pop-up screen below will be shown. It allows the user to select a display configuration suitable for that modality.

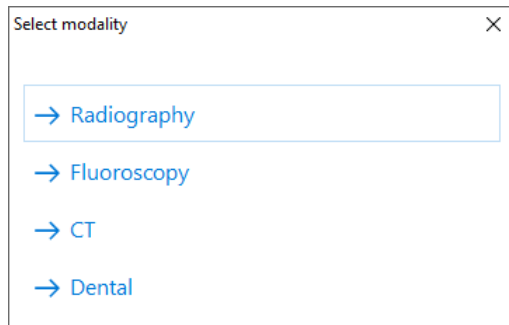

2.2.1 Measuring Radiography

Select "Radiography" in the pop-up menu.

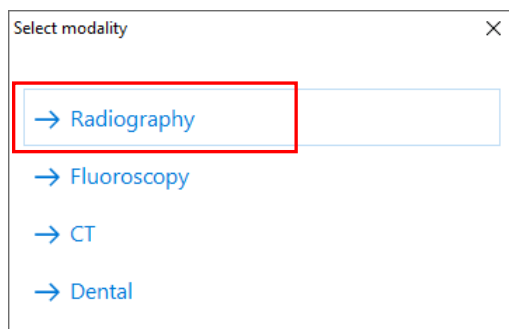

The following display configuration will be shown.

When status field shows "Ready", the system is ready to make a measurement.

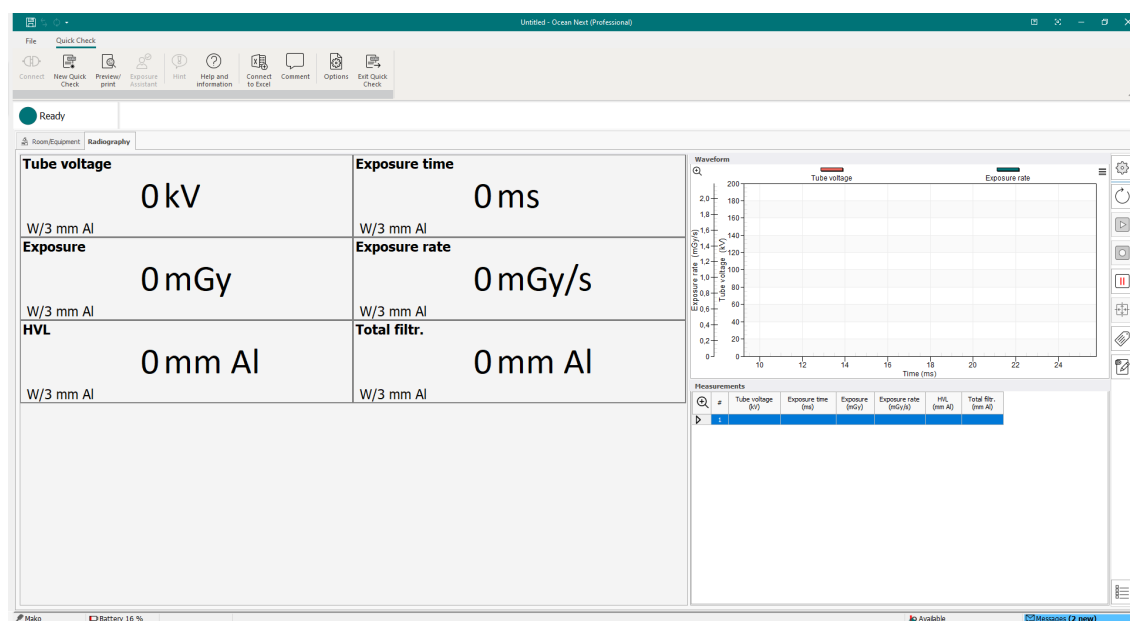

Place the probe in the X-ray field, ensuring that the active area (indicated by the white cross-hairs) is in the beam. Note that the detector is symmetrical and can be rotated in any direction as long as the active area is facing the source. Make an exposure.

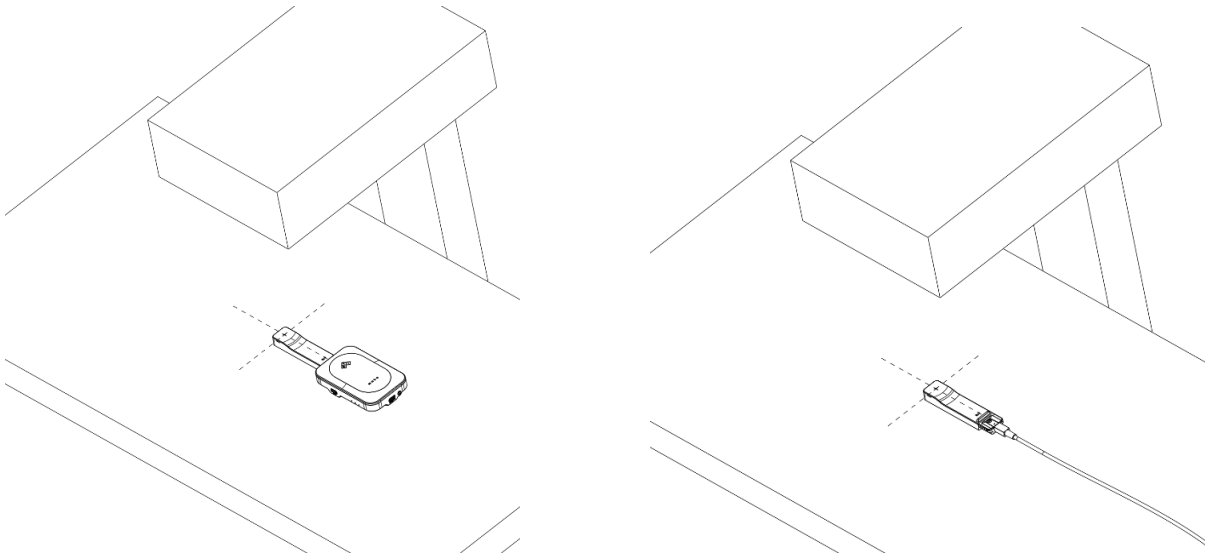

Measurement data for the latest exposure will be shown in the displays.

The window to the upper right will show the waveforms of kV and dose rate (Tube voltage and exposure rate) for the latest exposure.

To the lower right is a grid showing the measurement data for each exposure, row by row.

Change unit of measure by right-clicking on the unit of measure in the display and select a new unit of measure.

Save the measurement data file by clicking the save symbol to the upper left or clicking "File" and then "Save as..".

For more information on the Quick Check display, please refer to section [The Quick Check Display](#)

2.2.1.1 Measuring mA and mAs

For information on how to measure mA and mAs, please refer to section [Measuring mA and mAs](#)

2.2.1.2 Measuring dose with additional dose probe

For information on measuring with additional dose probe, please refer to section [Measuring with the Legacy Module](#)

2.2.1.3 Measuring with an Ion Chamber

For more information on measuring with an Ion Chamber, please refer to section [Measuring with Ion Chamber Module](#)

2.2.1.4 Measuring in Dental applications

For information on measuring in Dental applications, please refer to section [Measuring with the Dental probe](#)

2.2.2 Measuring Fluoroscopy

Select “Fluoroscopy” in the pop-up menu.

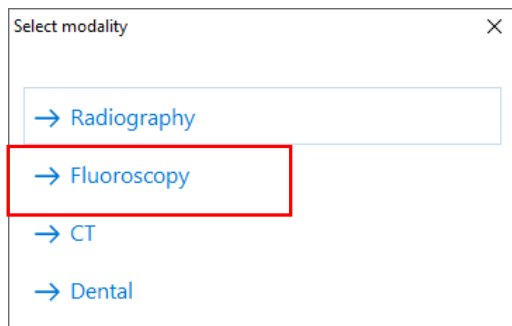

The following display configuration will be shown.

When status field shows “Ready”, the system is ready to make a measurement.

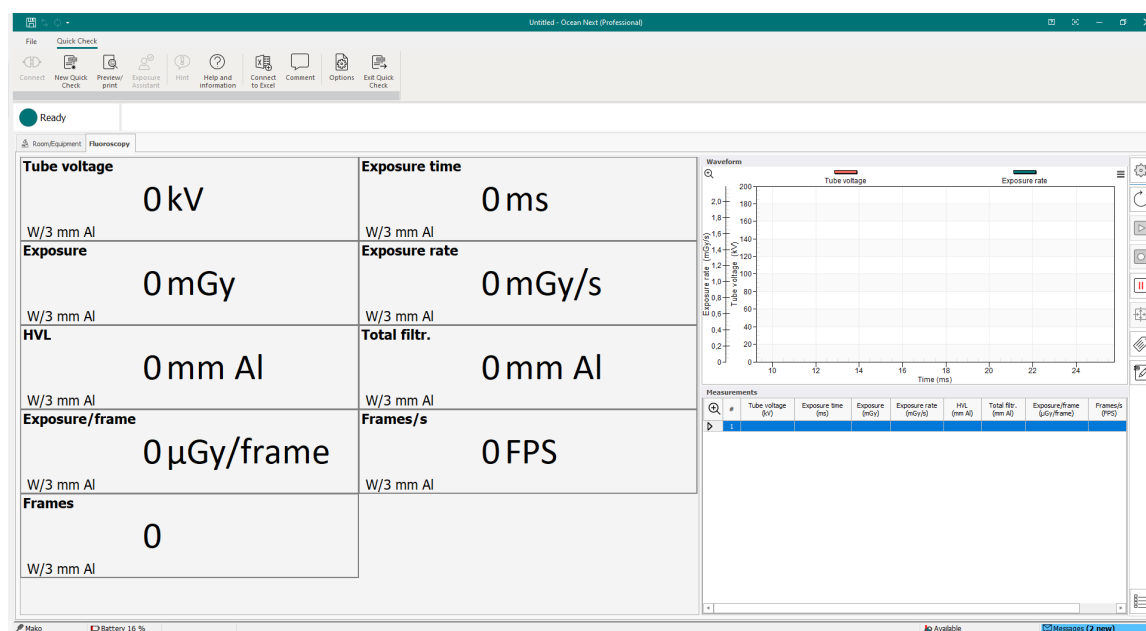

Place the probe in the X-ray field, ensuring that the active area (indicated by the white cross-hairs) is in the beam and faces the source. Note that the detector is symmetrical and can be rotated in any direction as long as the active area is facing the source. Make an exposure.

2.2.2.1 Measuring mA and mAs

For information on how to measure mA and mAs, please refer to section [Measuring mA and mAs](#)

2.2.2.2 Measuring dose with additional dose probe

For information on measuring with additional dose probe, please refer to section [Measuring with the Legacy Module](#)

2.2.2.3 Measuring with an Ion Chamber

For information on measuring with additional dose probe, please refer to section [Measuring with Ion Chamber Module](#)

2.2.3 Measuring CT

Select “CT” in the pop-up menu.

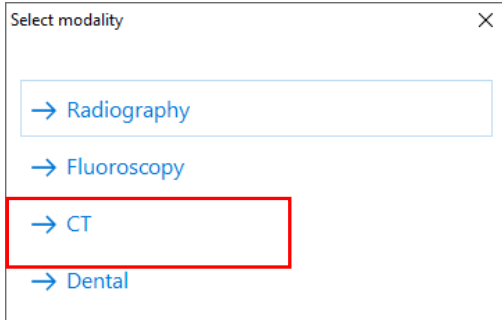

2.2.3.1 Measuring with R/F probe in a CT scanner

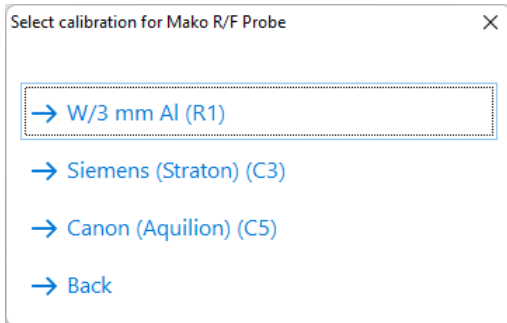

Measuring kV, HVL and Total Filtration in a CT scanner can be done using the Mako R/F Probe. Siemens scanners with a Straton tube and Canon Aquilion scanners produce unique radiographic spectra which requires a specific Beam Quality selection. All other CT scanners are compatible with the Beam Quality selection W/3 mm Al. This selection covers all other CT scanners including GE scanners with 7-, 10- and 10.5-degree anode angles, scanners from Philips, Fuji and others.

Select the appropriate beam quality.

The following display configuration will be shown.

When status field shows “Ready”, the system is ready to make a measurement.

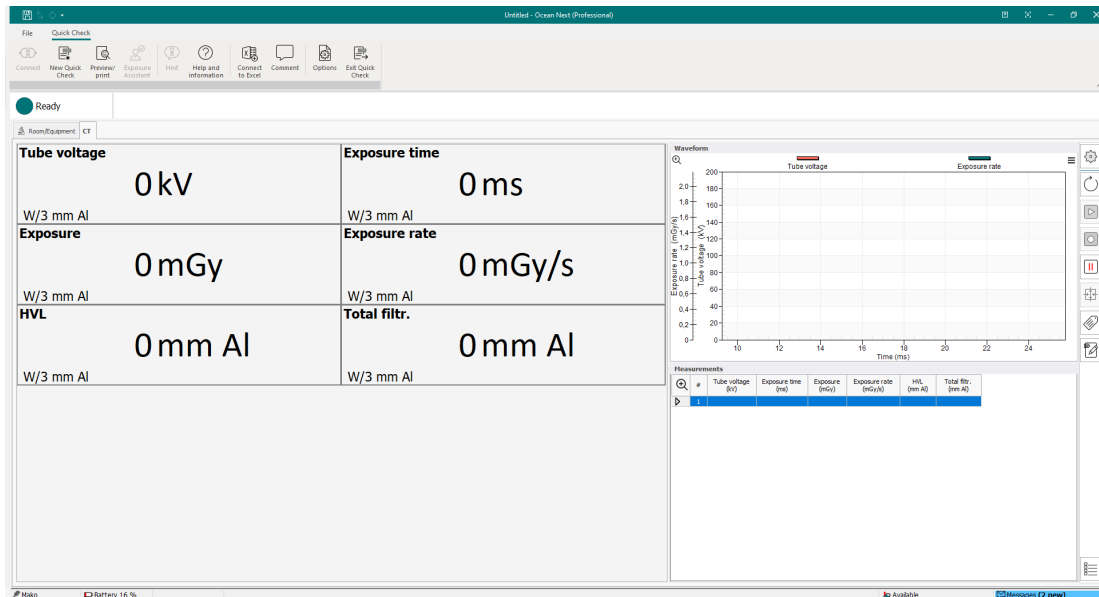

Place the probe in the beam making sure that the detector area is fully irradiated.

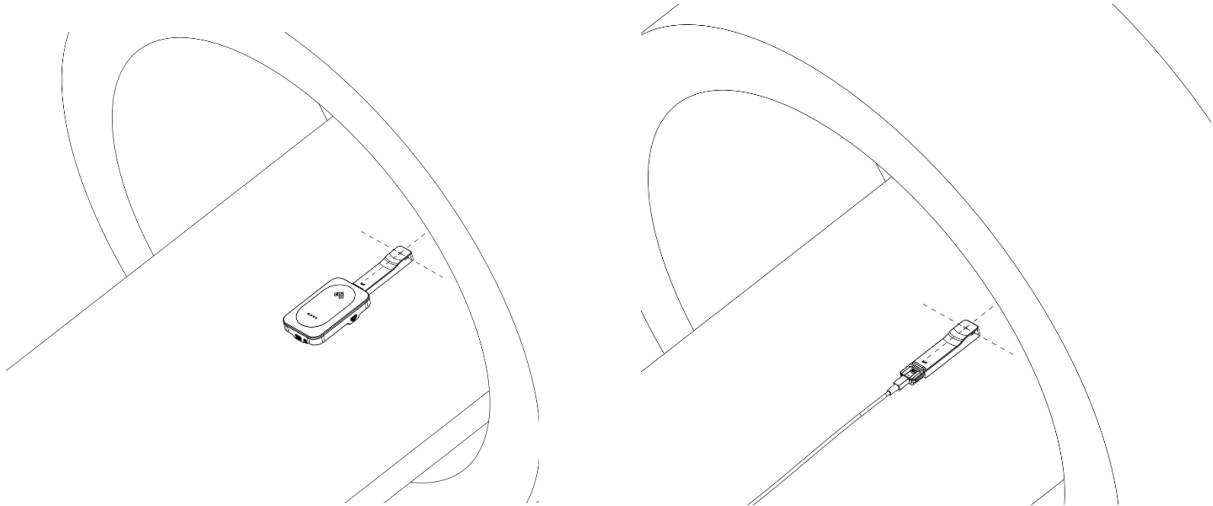

In case the detector is not fully irradiated, Mako offers a probe positioning help function that guides the user to the correct positioning of the probe in a narrow X-ray beam, e.g. in CT or Panoramic Dental.

The function utilizes the segmentation of the detector to determine whether the center segment is fully irradiated or not. By evaluating the balance in radiation to the surrounding segments, it can be deduced how to move the probe to a better position.

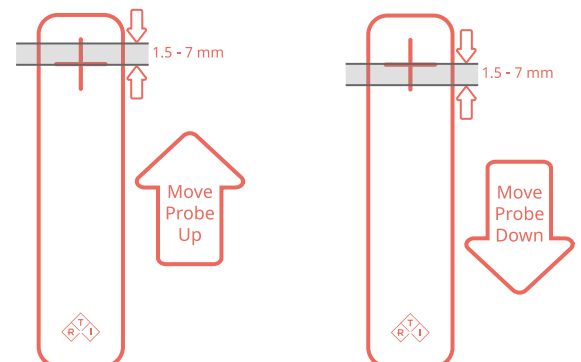

2.2.3.2 Measuring CTDI with the CT Ion Chamber

For information about measuring CTDI, please refer to section [Measuring with Ion Chamber Module](#)

2.2.3.3 Measuring CTDI with the CT Dose Profiler

For information about measuring CTDI, please refer to section [Measuring with the CT Dose Profiler](#)

2.2.3.4 Measuring Beam Width

For information about measuring CTDI, please refer to section [Measuring with the CT Dose Profiler](#)



2.2.4 Measuring Dental

Select “Dental” in the pop-up menu.

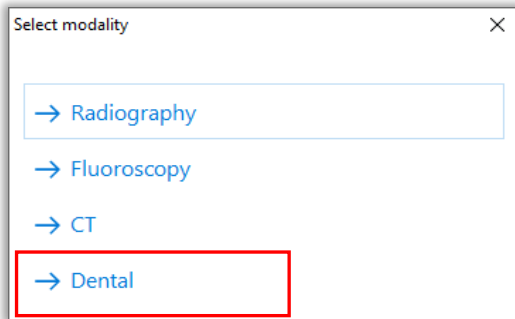

In dental applications, the R/F Probe has the same functionality as the Dental Probe. For information on how to measure in Dental applications, please refer to section [Measuring with the Dental Probe](#)

2.2.5 Settings for the R/F Probe

For more information about settings for the R/F Probe, please see section [Meter Settings](#)

2.3 Measuring with the Mammo Probe

With the Mammo Probe connected, the pop-up screen below will be shown. It allows the user to select a suitable beam quality for that measurement.

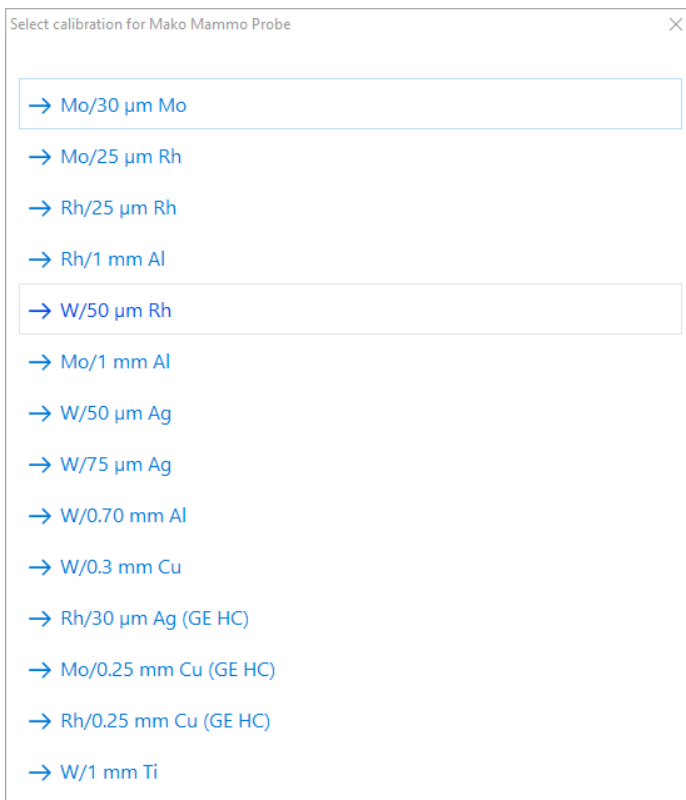

The beam qualities in the list can cover a wider range of filter thickness than is stated in the name. E.g. beam quality W/0.7mm Al is suitable for mammography machines using Al filter with a thickness between 0.5 and 0.9 mm (see table below).

Beam Quality	Filter thickness range
W / 0.70 mm Al	0.5 – 0.9 mm Al
W / 50 μ m Rh	45 – 65 μ m Rh
W / 50 μ m Ag	45 – 55 μ m Ag
W / 75 μ m Ag	70 – 80 μ m Ag
W / 0.30 mm Cu	0.25 – 35 mm Cu
W / 1 mm Ti	1 – 1.5 mm Ti
Mo / 30 μ m Mo	25 – 35 μ m Mo
Mo / 25 μ m Rh	20 – 30 μ m Rh
Mo / 1.0 mm Al	0.8 – 1.2 mm Al
Mo / 0.25 mm Cu	0.25 – 35 mm Cu
Rh / 25 μ m Rh	20 – 30 μ m Rh
Rh / 1.0 mm Al	0.8 – 1.2 mm Al
Rh / 30 μ m Ag	25 – 35 μ m Ag
Rh / 0.25 mm Cu	0.25 – 35 mm Cu

Please note there is no need to select if paddle is in the beam or not.

2.3.1 Measuring Mammography

Select the appropriate beam quality. The following display configuration will be shown. When status field shows “Ready”, the system is ready to make a measurement.

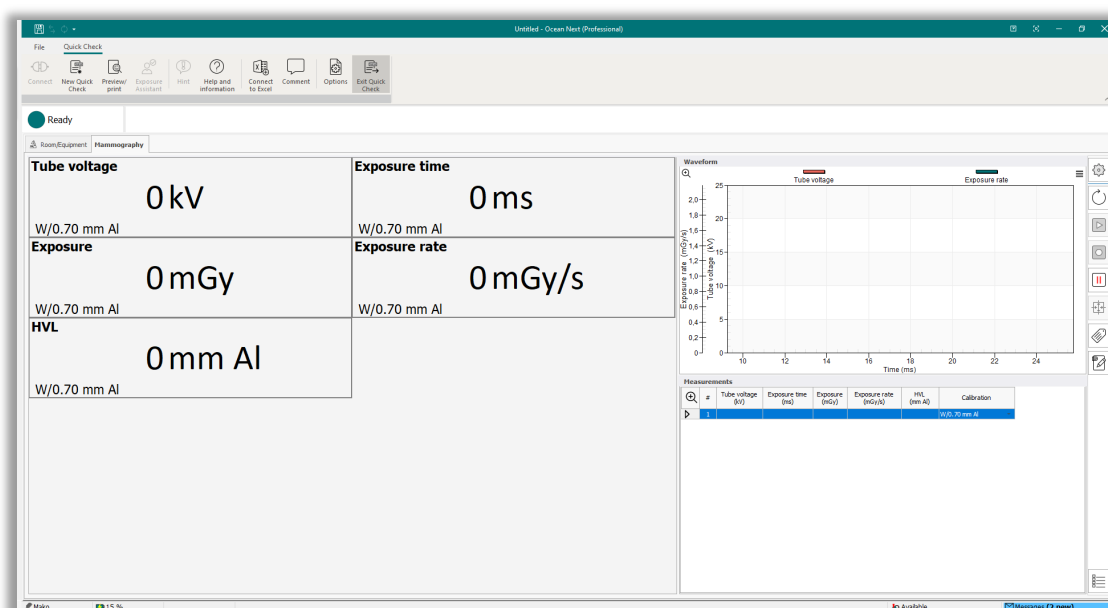

Place the probe in the X-ray field, ensuring that the active area (indicated by the white cross-hairs) is in the beam. Note that the detector is symmetrical and can be rotated in any direction as long as the active area is facing the source.

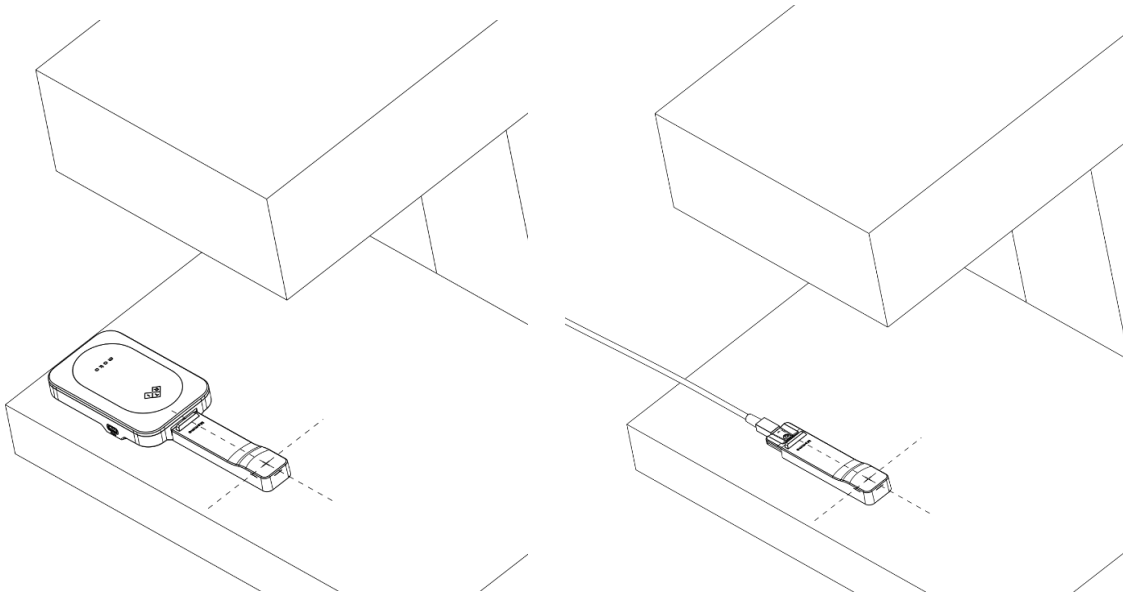

Make an exposure. Measurement data for the latest exposure will be shown in the displays.

The window to the upper right will show the waveforms of kV and dose rate (Tube voltage and exposure rate) for the latest exposure.

To the lower right is a grid showing the measurement data for each exposure, row by row. Note that beam quality used for each exposure is recorded for traceability.

To change beam quality, right click on the beam quality designation in one of the displays and make a selection from that pop-up menu. The beam quality recorded in the grid will be changed from that row onwards.

Change unit of measure by right-clicking on the unit of measure in the display and select a new unit of measure.

Save the measurement data file by clicking the save symbol to the upper left or clicking "File" and then "Save as..".

For more information on the Quick Check display, please refer to section [The Quick Check Display](#)

2.3.2 Measuring Tomographic Mammography

In tomographic mode, place the Mammo Probe as above. Stationary mode may be considered taking the following into account: nominal accuracy maintained within

- kV: +/- 15 degrees from vertical
- dose, HVL: 30 degrees from vertical

For units with tomographic sweeps wider than the above, stationary mode can be considered.

2.3.3 Measuring Mammography in Combo Mode (2D+3D)

In Combo Mode, a 3D tomographic exposure sweep is immediately followed by a 2D stationary exposure. To measure dose and HVL, place the probe as above and start the sequence. Since there usually is a change of filter going from 3D to 2D, and the time to change beam quality is too short, the kV measurement may not be fully correct.

To get a correct measurement also of kV, please use the Ocean Next template for Combo Mode which can be found in Examples (RTI).

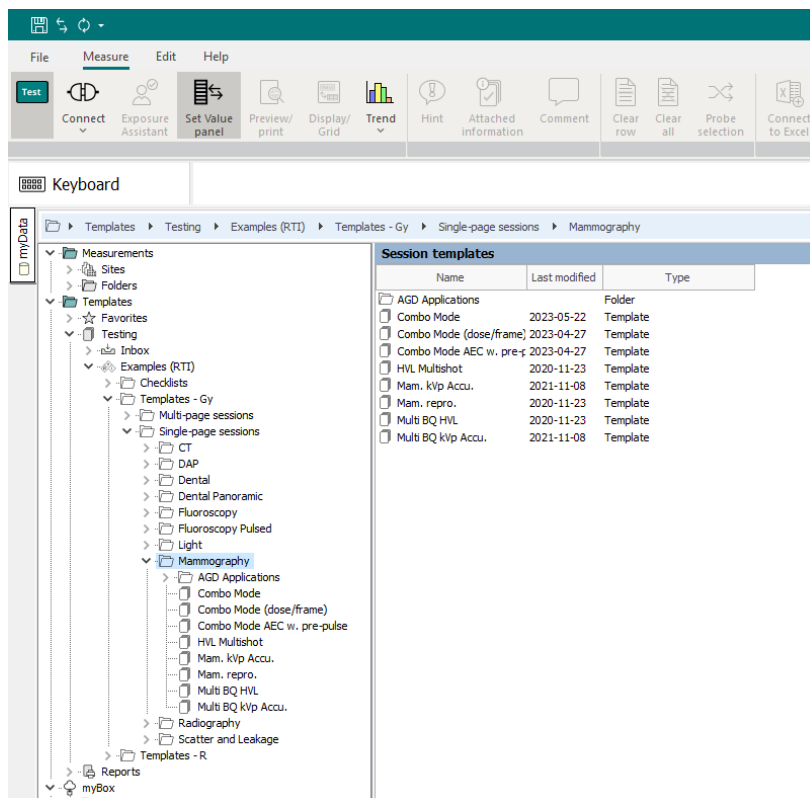

2.3.4 Measuring Scanning Mammography

For scanning mammo units, place Mammo Probe as above.

2.3.5 Measuring mA and mAs

For information on how to measure mA and mAs, please refer to section [Measuring mA and mAs](#)

2.3.6 Measuring dose with additional probe

For information on measuring with additional dose probe, please refer to section [Measuring with the Legacy Module](#)

2.3.7 Measuring with an Ion Chamber

For information about measuring with an Ion Chamber in Mammography, please refer to section [Measuring with Ion Chamber Module](#)

2.3.8 Settings for the Mammo Probe

For more information about settings for the Mammo Probe, please see section [Meter Settings](#)

2.4 Measuring with the Dental Probe

With the Dental Probe connected, the following display configuration will be shown.

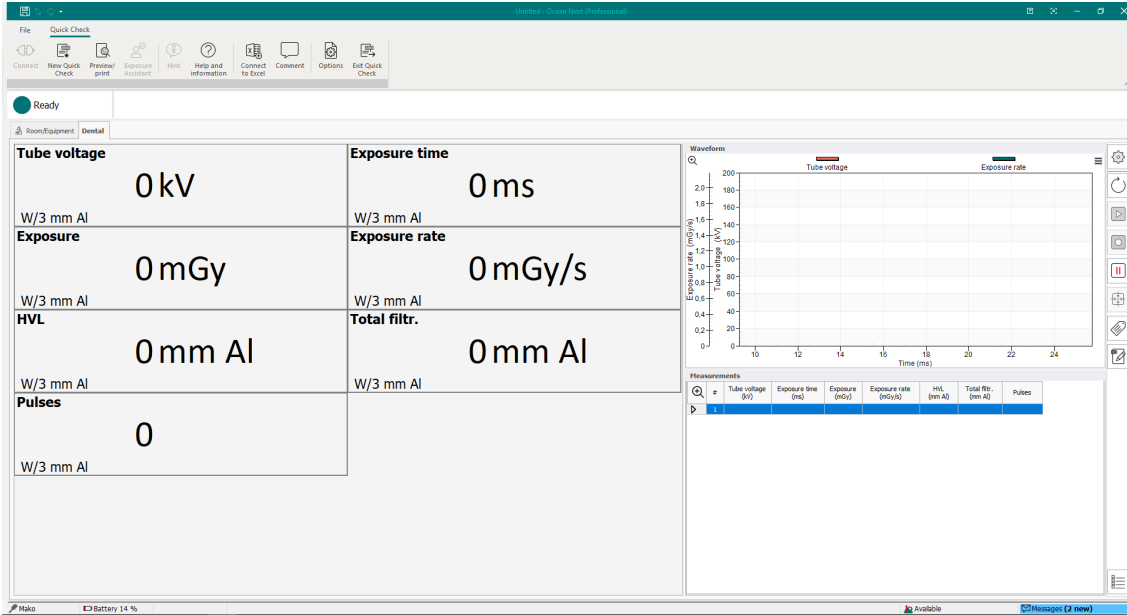

When status field shows “Ready”, the system is ready to make a measurement.

2.4.1 Measuring on Intraoral Dental

Place the probe in the X-ray field, ensuring that the active area (indicated by the white cross-hairs) is in the beam. Note that the detector is symmetrical and can be rotated in any direction as long as the active area is facing the source.

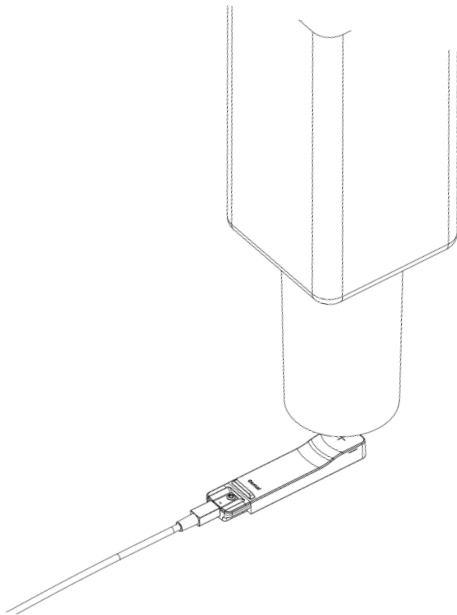

Make an exposure. Measurement data for the latest exposure will be shown in the displays.

The window to the upper right will show the waveforms of kV and dose rate (Tube voltage and exposure rate) for the latest exposure.

To the lower right is a grid showing the measurement data for each exposure, row by row.

Change unit of measure by right-clicking on the unit of measure in the display and select a new unit of measure.

Save the measurement data file by clicking the save symbol to the upper left or clicking "File" and then "Save as..".

For more information on the Quick Check display, please refer to section [The Quick Check Display](#)

2.4.2 Measuring on Panoramic Dental

Use the Mako Dental Holder to mount the probe in the beam. Loosen the locking screw and slide the probe in its holder sideways to position the probe correctly in the beam.

In some cases, it is possible that the Mako Base Unit can be held in place by the strap on the rear of the Panoramic detector housing.

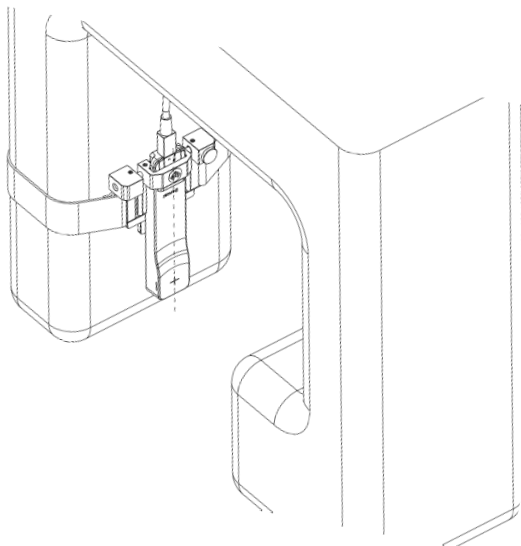

In case the detector is not fully irradiated, Mako offers a probe positioning help function that guides the user to the correct positioning of the probe in a narrow X-ray beam, e.g. in Panoramic Dental.

The function utilizes the segmentation of the detector to determine whether the center segment is fully irradiated or not. By evaluating the balance in radiation to the surrounding segments, it can be deduced how to move the probe to a better position.

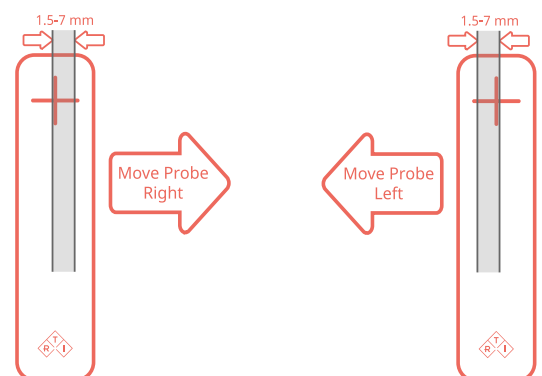

Make an exposure. Measurement data for the latest exposure will be shown in the displays.

The window to the upper right will show the waveforms of kV and dose rate (Tube voltage and exposure rate) for the latest exposure.

To the lower right is a grid showing the measurement data for each exposure, row by row.

Change unit of measure by right-clicking on the unit of measure in the display and select a new unit of measure.



2.4.3 Measuring on Dental CBCT

2.4.3.1 Measuring kV, dose, HVL and TF in Dental CBCT

Mount the probe as on a Panoramic Dental unit, above.

Make an exposure. Measurement data for the latest exposure will be shown in the displays.

The window to the upper right will show the waveforms of kV and dose rate (Tube voltage and exposure rate) for the latest exposure.

To the lower right is a grid showing the measurement data for each exposure, row by row.

Change unit of measure by right-clicking on the unit of measure in the display and select a new unit of measure.

2.4.3.2 Measuring DAP in Dental CBCT

For information about measuring DAP in Dental CBCT, please refer to section [Measuring with Ion Chamber Module](#)

2.5 Measuring mA and mAs

With the Mako mAs module mA and mAs can be measured in 3 different ways:

1. The standard Mako mA cable is designed for invasive measurement of mA and mAs i.e. with the red and black connectors directly connected to the generator (usually after removing the jumper over the mA break out point)
2. The optional MAS-2 clamp-on probe is designed for a non-invasive mA and mAs measurement. It is clamped on to the high-tension cable (cathode side) and uses the magnetic field generated outside the high-tension cable to evaluate the current, i.e. the mA and thus mAs. Since the magnetic field can be quite weak, MAS-2 should be used together with the R/F or Mammo Probe that is placed in the X-ray field. The measurement is triggered by radiation detected by the probe.

With MAS-2 probe the display configuration will always show mA, mAs as well as measurement data from the probe (kV, dose, dose rate, exposure time and HVL)

3. The Mako Test Point Cable is intended for connection to defined test points on the generator controller board. These test points produce a voltage that is proportional to the tube current, mA. The voltage is converted to mA using a scale factor stored in the mAs module.

With the mAs module connected on its own, the following display configuration will appear (note that the MAS-2 option required simultaneous connection of an R/F or Mammo Probe).

Here the user has the possibility to measure the tube current, mA, exposure time as well as mAs.

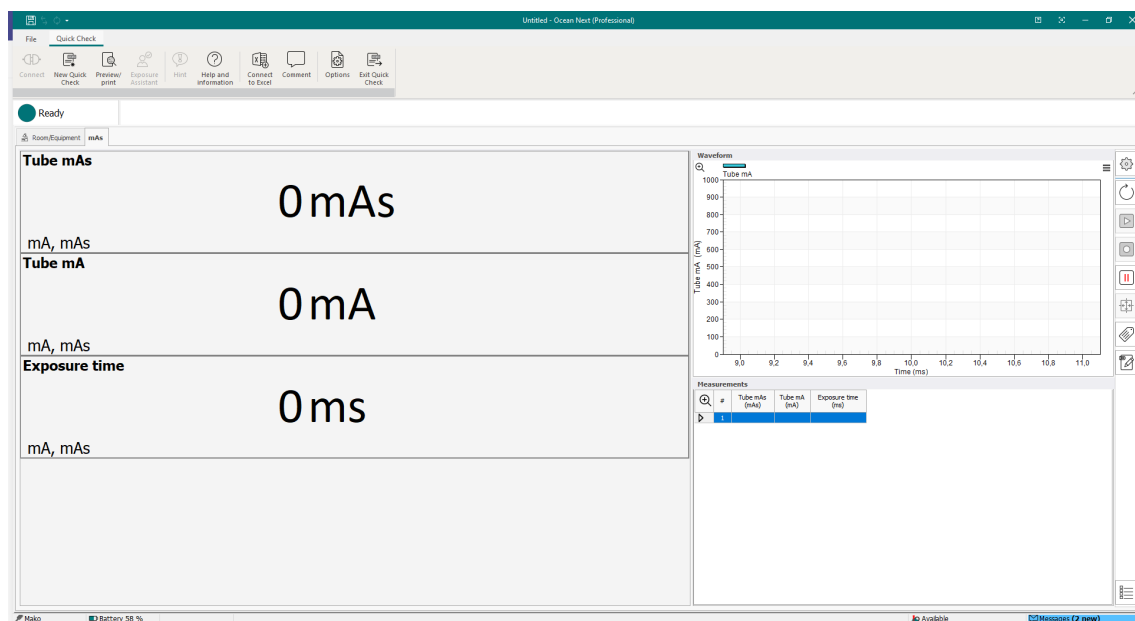

Make an exposure. Measurement data for the latest exposure will be shown in the displays.

The window to the upper right will show the waveforms of mA (tube current) for the latest exposure.

To the lower right is a grid showing the measurement data for each exposure, row by row.

Change unit of measure by right-clicking on the unit of measure in the display and select a new unit of measure.

If the mAs module is connected in parallel with the R/F Probe or the Mammo Probe the following pop-up will appear, given the user the choice of measurement configuration.

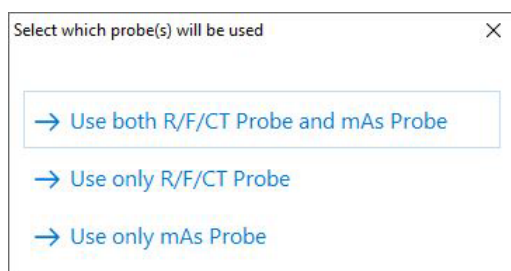

If “use only external probe” is selected, the display configuration above will appear, showing only mA, mAs and exposure time.

If selecting “both external and internal probe” is made a pop-up screen will appear with the choice of modality. If Radiography is selected the following screen will appear showing mA, mAs as well as measurement data from the probe (R/F or Mammo), kV, exposure time, dose, dose rate, HVL and Total Filtration. If Fluoroscopy is selected additional screens will appear showing mAs per frame as well as frame rate, number of frames and dose per frame.

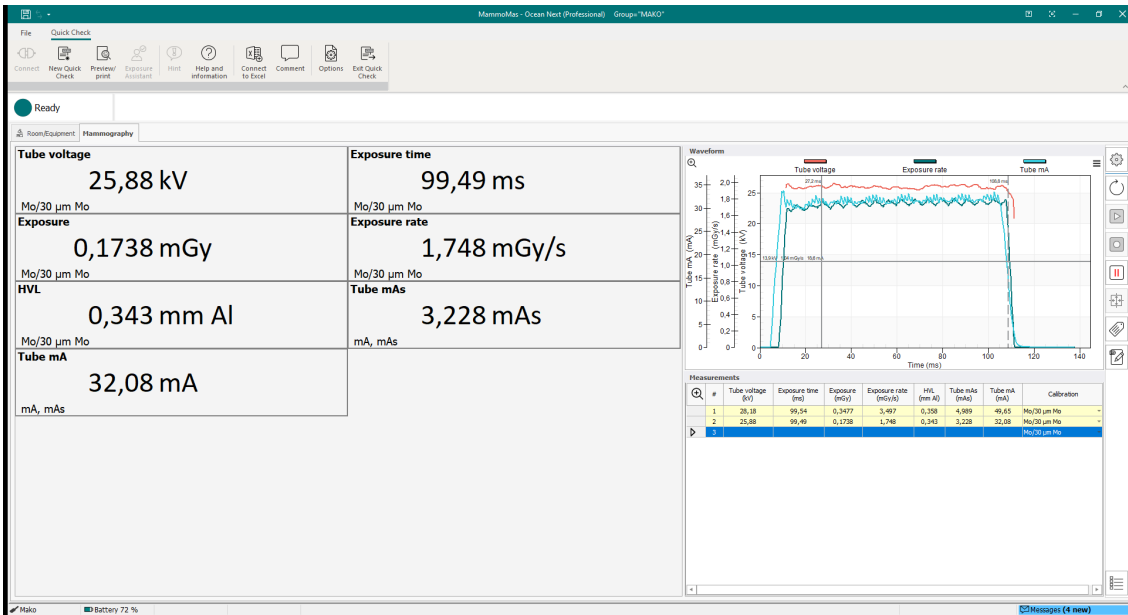

Make an exposure. Measurement data for the latest exposure will be shown in the displays.

The window to the upper right will show the waveforms of kV, dose rate and mA (tube current) for the latest exposure.

To the lower right is a grid showing the measurement data for each exposure, row by row.

Change unit of measure by right-clicking on the unit of measure in the display and select a new unit of measure.

2.6 Measuring with Ion Chamber Module

The Mako Ion Chamber module contains the electrometer and bias voltage supply for ion chambers of different kinds, e.g. CT Ion Chamber, Magna Ion Chamber and DAP Chambers.

For compatibility with the Mako Ion Chamber module, ion chambers must have LEMO connector and be equipped with a PID dongle which stores calibration data for the ion chamber. When the ion chamber is connected, the PID dongle is attached magnetically thereby activating the bias voltage.

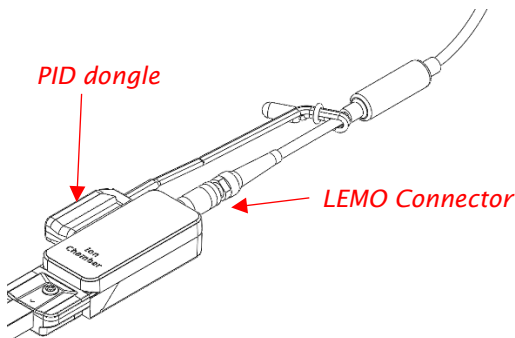

Since Ion Chambers rarely are used together with other probes, the display defaults to a suitable configuration which is determined from the information stored on the PID dongle.

2.6.1 Measuring with CT Ion Chamber

When the Ion Chamber Module is connected to the Mako Base Unit and the RTI CT Ion Chamber and PID dongle are connected, the screen below will appear.

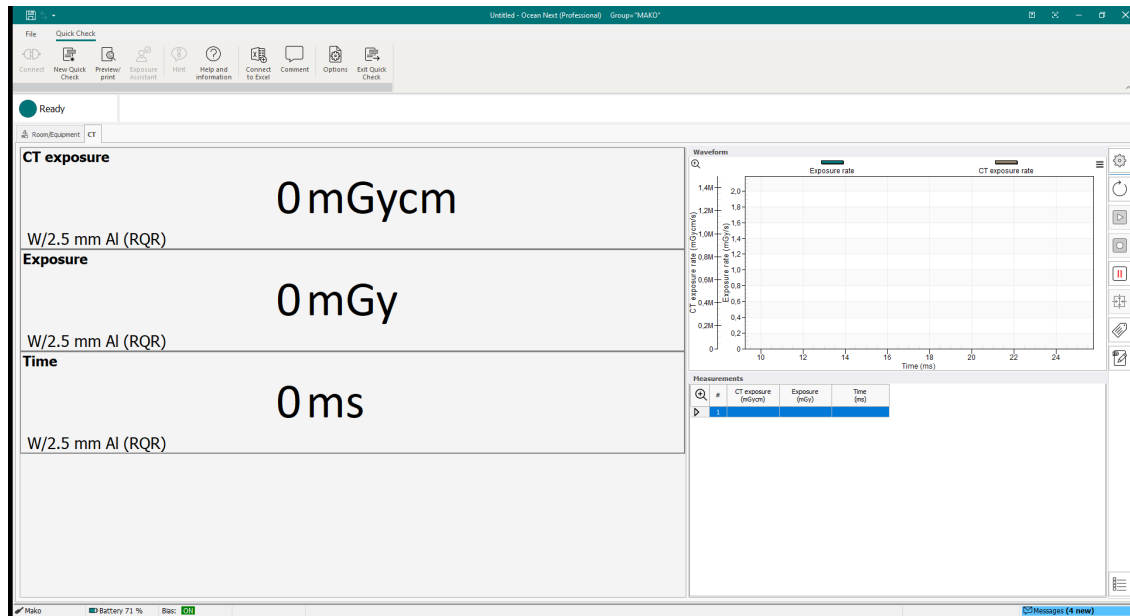

Insert the RTI CT Ion Chamber into the phantom in the proper position.

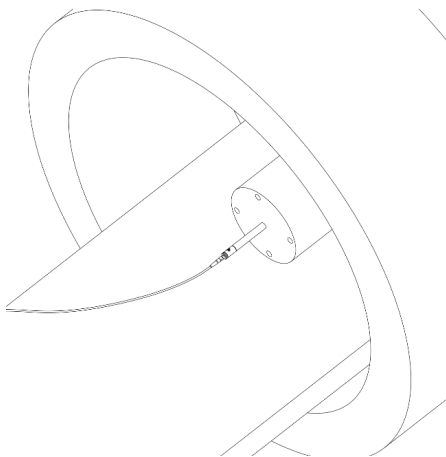

Make an exposure. Measurement data for the latest exposure will be shown in the displays.

The window to the upper right will show the waveforms of dose rate for the latest exposure.

To the lower right is a grid showing the measurement data for each exposure, row by row.

Change unit of measure by right-clicking on the unit of measure in the display and select a new unit of measure.

Save the measurement data file by clicking the save symbol to the upper left or clicking "File" and then "Save as..".



For more information on the Quick Check display, please refer to section [The Quick Check Display](#).

TIP:

To avoid self-triggering when moving the CT Ion Chamber between holes in the CT phantom, press the Pause button. When the CT Ion Chamber has been moved, press the Pause button again to resume measurement.

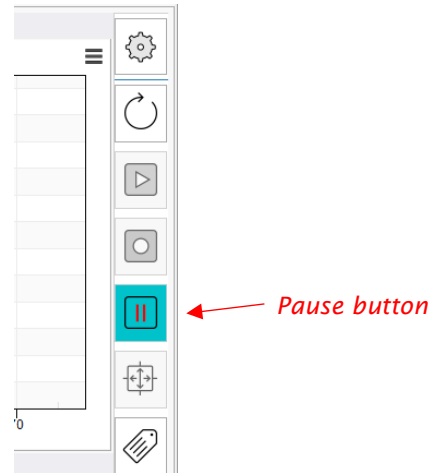

2.6.2 Measuring DAP

When the Ion Chamber Module is connected to the Mako Base Unit and the DAP Chamber and PID dongle are connected, the screen below will appear.

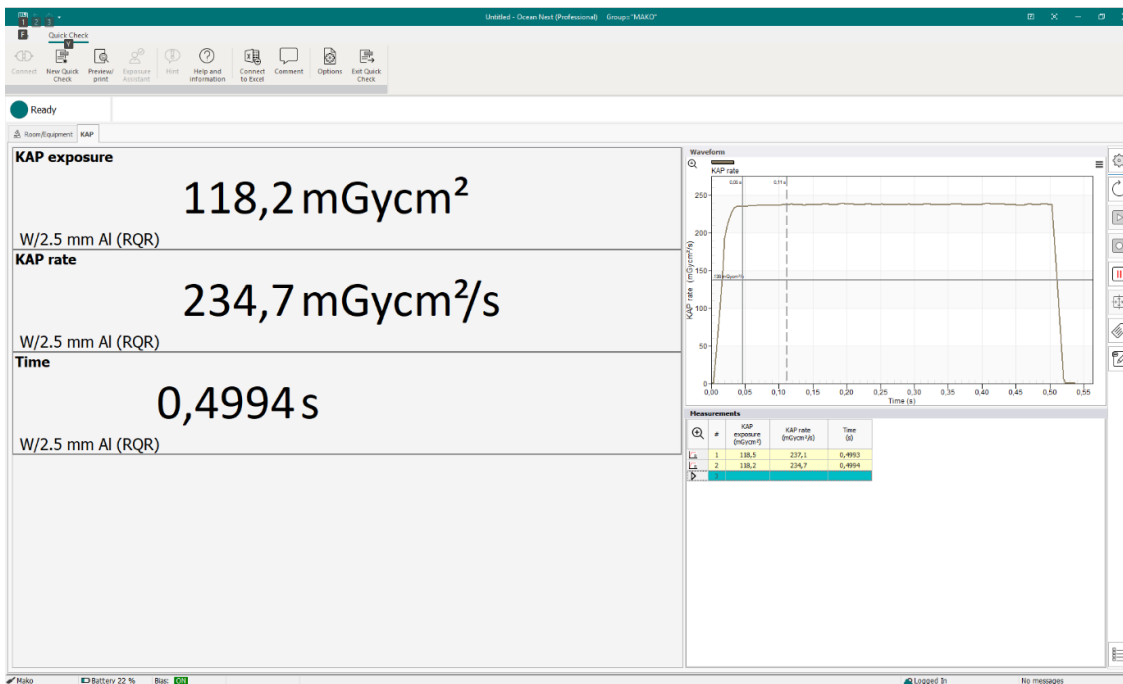

Position the DAP Chamber appropriately, ensuring that the X-ray beam will pass within the frames of the DAP Chamber. (for Dental CBCT, place the DAP Chamber close to the tube exit port e.g. by affixing it with surgical tape).

Make an exposure. Measurement data for the latest exposure will be shown in the displays.

The window to the upper right will show the waveforms of DAP rate for the latest exposure.

To the lower right is a grid showing the measurement data for each exposure, row by row.

Change unit of measure by right-clicking on the unit of measure in the display and select a new unit of measure.

Save the measurement data file by clicking the save symbol to the upper left or clicking “File” and then “Save as..”.

For more information on the Quick Check display, please refer to section [The Quick Check Display](#)

2.6.3 Measuring with Magna Ion Chamber

When the Ion Chamber Module is connected to the Mako Base Unit and the Magna Chamber and PID dongle are connected, the screen below will appear.

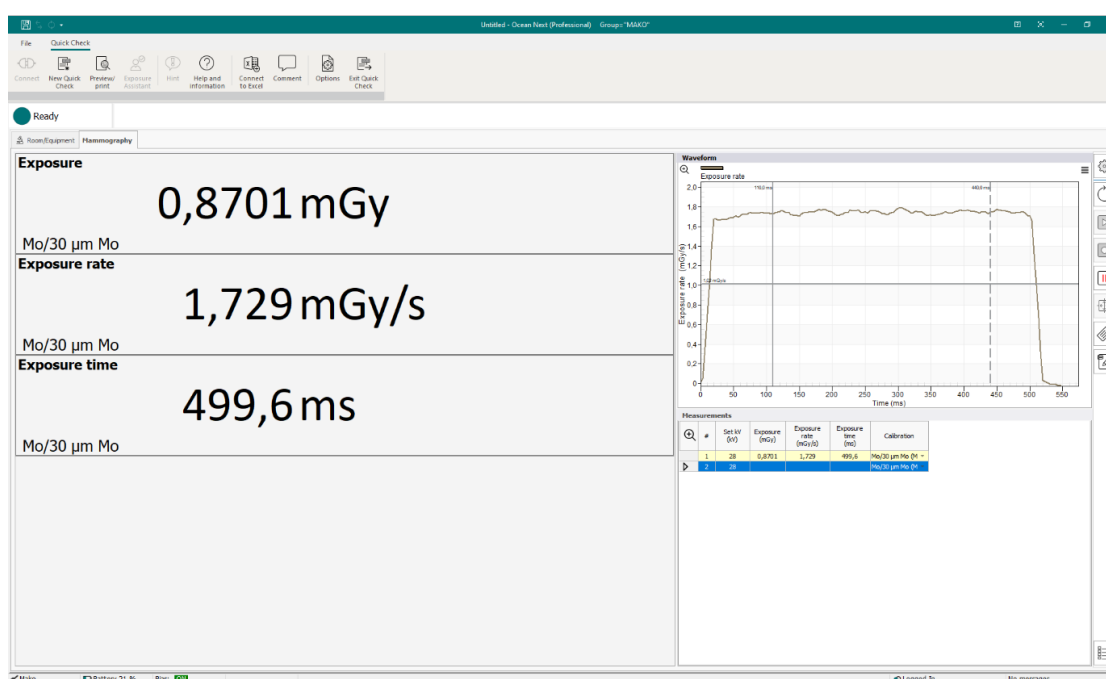

Position the Magna Chamber appropriately, ensuring that the whole ion chamber is in the X-ray beam.

Make an exposure. Measurement data for the latest exposure will be shown in the displays.

The window to the upper right will show the waveforms of dose rate for the latest exposure.

To the lower right is a grid showing the measurement data for each exposure, row by row.

Change unit of measure by right-clicking on the unit of measure in the display and select a new unit of measure.

Save the measurement data file by clicking the save symbol to the upper left or clicking “File” and then “Save as..”.

For more information on the Quick Check display, please refer to section [The Quick Check Display](#)



2.6.4 Measuring with non-RTI Ion Chambers

Ion Chambers from other suppliers than RTI may be compatible with the Mako System provided that they are fitted with a LEMO connector and that they are equipped with a PID dongle.

Please contact your RTI representative to explore whether a PID dongle can be issued separately.

2.6.5 Settings for the Ion Chamber Module

For more information about settings for the Ion Chamber Module, please see section [Meter Settings](#)

2.7 [Measuring with the Legacy Module](#)

The Mako Legacy Module is the interface for RTI Probes already in use with the Piranha and Cobia systems. It allows users of Piranha and/or Cobia to re-use their probes together with the Mako system. Probes compatible with the Mako Legacy Module are:

- *RTI Light Probe*
- *RTI CT Dose Profiler*
- *RTI Dose Probe*
- *RTI T 20*
- *RTI MAS-1*
- *RTI MAS-2*
- *RTI Test Point Cable*

2.7.1 Measuring with the RTI Light Probe

The RTI Light Probe has two different adapters to measure the quantities luminance and illuminance. The most common applications for the RTI Light Probe are luminance (cd/m^2) measurements on monitors and viewing boxes, and illuminance (lx) measurements of ambient light in a room or in front of a monitor or to measure collimator light.

Since light meters rarely are used in conjunction with other probes, the pop-up display below appears when the RTI Light Probe is connected to the Legacy Module.

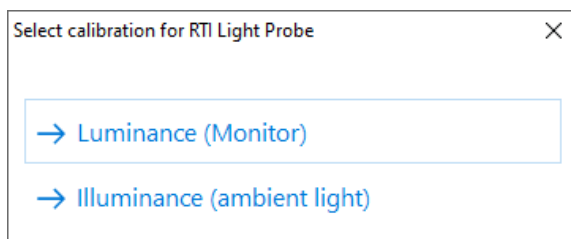

2.7.1.1 Measuring Luminance

Selecting Luminance, the screen below will appear, and the system is ready to measure.

Position the monitor shield over the appropriate test pattern area by aiming through the monitor shield and insert monitor adapter.

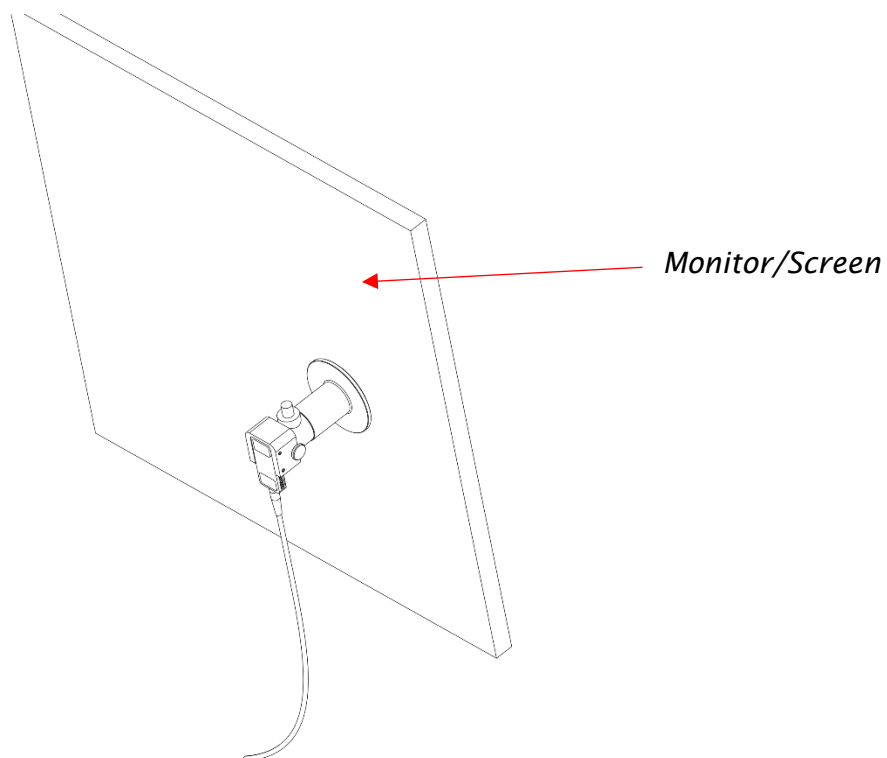
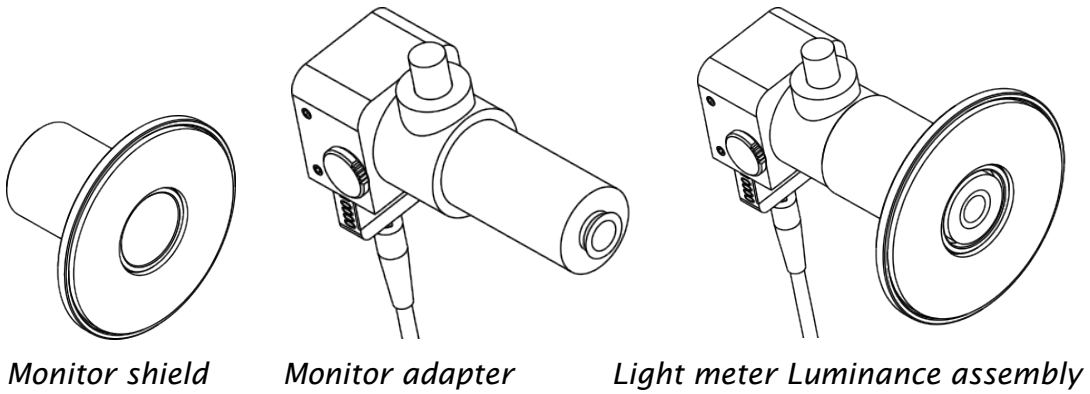

*Press the shutter button and keep depressed until measurement value stabilizes.
Measurement data for the latest exposure will be shown in the displays.*

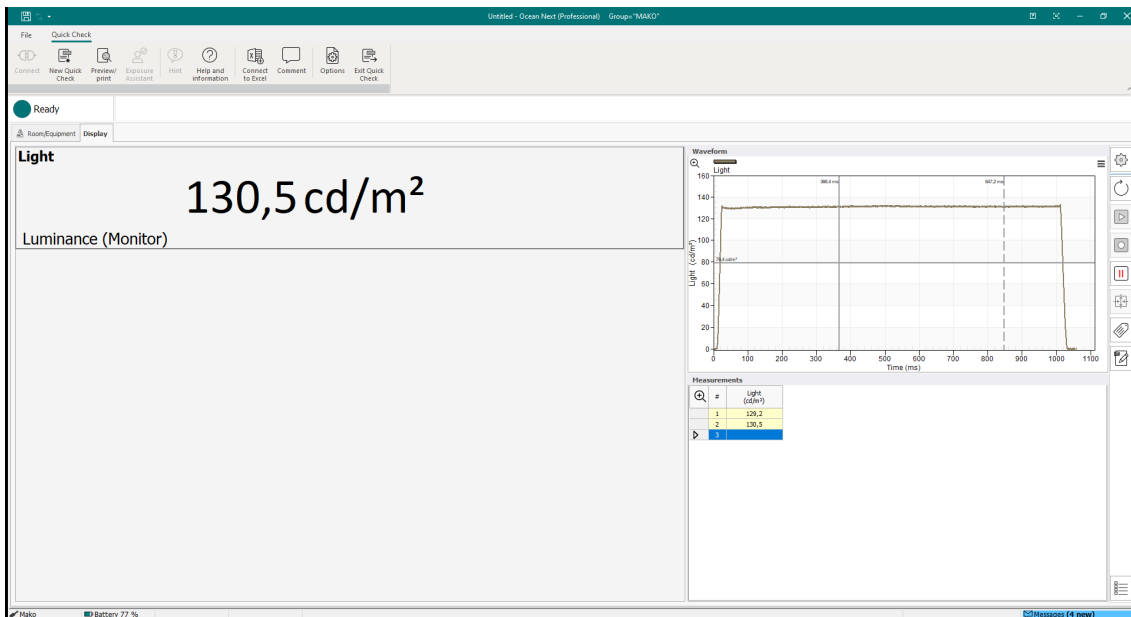

The window to the upper right will show the waveforms of luminance for the latest measurement. To the lower right is a grid showing the measurement data for each measurement, row by row.

Change unit of measure by right-clicking on the unit of measure in the display and select a new unit of measure.

Save the measurement data file by clicking the save symbol to the upper left or clicking "File" and then "Save as..".

For more information on the Quick Check display, please refer to section [The Quick Check Display](#)

Remove the monitor adapter and repeat for other test pattern areas.

2.7.1.2 Measuring Illuminance

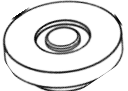
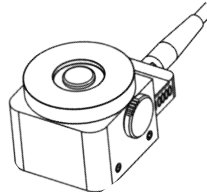
Ensure that the Lux adapter  is mounted properly. 

After selecting Illuminance, the pop-up below will appear.

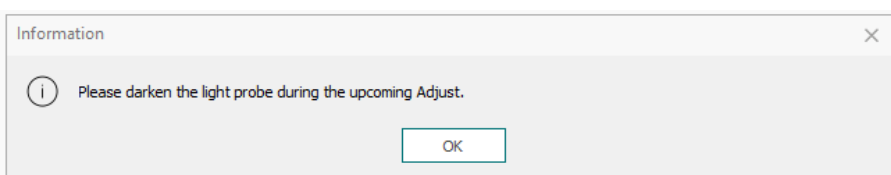

Keep the Lux adapter completely covered/darkened until the measurement screen appears and the reset procedure is complete.

This is a procedure that resets the RTI Light Probe to complete darkness.

Position the RTI Light Meter appropriately and press the Start button to the right of the waveform window.

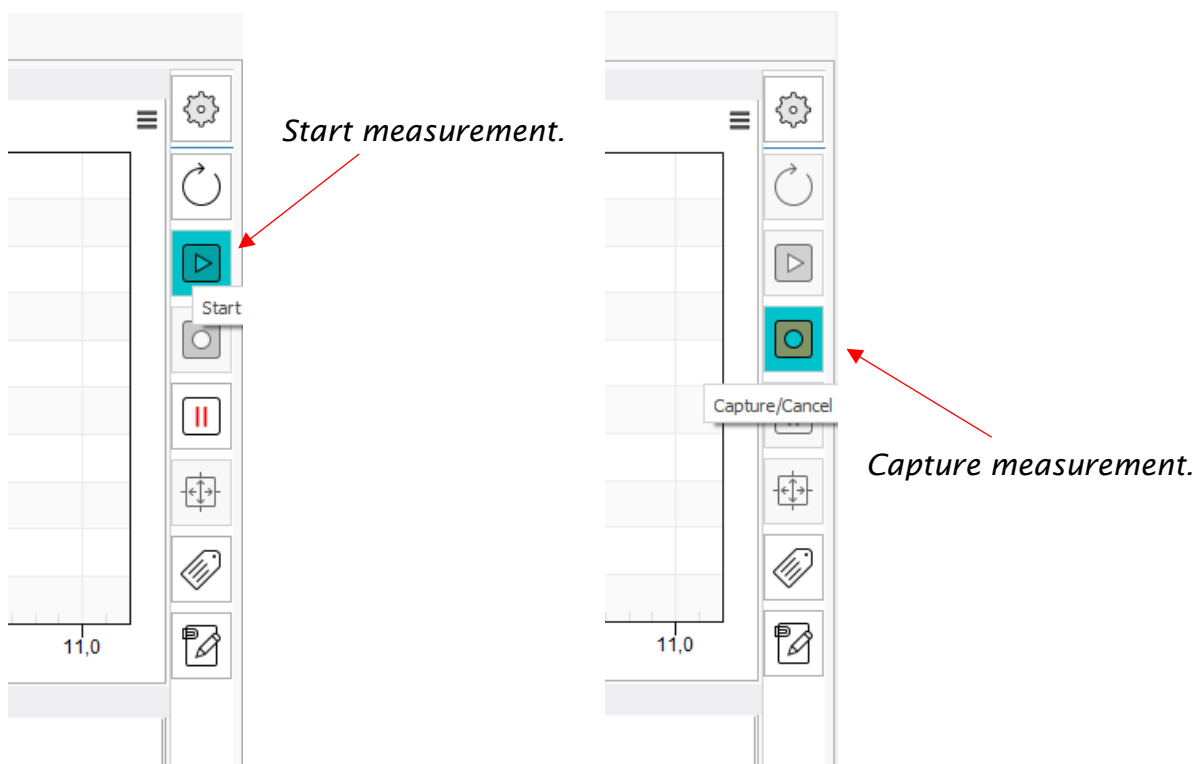

The measurement will start, and measurement data appears in the displays. When the lux values stabilize, press the Capture button to the right of the waveform window to stop measurement.

Measurement data for the latest exposure will be shown in the displays.

The window to the upper right will show the waveforms of illuminance for the latest measurement. To the lower right is a grid showing the measurement data for each measurement, row by row.

Change unit of measure by right-clicking on the unit of measure in the display and select a new unit of measure.

Save the measurement data file by clicking the save symbol to the upper left or clicking "File" and then "Save as..".

2.7.2 Measuring with the CT Dose Profiler

The RTI CT Dose Profiler is a point dose detector with a form factor of a traditional CT Ion Chamber. Moving the CT Dose Profiler through the CT beam, knowing the speed of travel and the sampling rate of the point dose detector, the dose profile can be calculated with high accuracy. This is the principle used for both CTDI measurement and CT Beam Width measurements.

2.7.2.1 Measuring CTDI with the RTI CT Dose Profiler

Place the CT phantom in the iso-center. Insert the CT Dose Profiler in the center hole of the CT Phantom so that the PMMA tip of the CT Dose Profiler is flush with the flat side of the CT Phantom and the point-dose detector is centered. Connect the CT Dose Profiler to the Legacy Module which should be connected to the Mako Base Unit.



Prepare the scanner for a helical scan of the complete CT phantom including some margin before and after CT phantom.

To measure CTDI with the RTI CT Dose Profiler, a special template is needed. It can be activated by clicking on Favorites and selecting CTDI (CT Dose Profiler).

In the template that loads, the user first needs to select the type of scanner (this selects the appropriate k-factor from an empirical database, ensuring the proper conversion between dose in the center hole and dose in the peripheral holes of the phantom), then the user needs to enter set values that match those of the CT Scanner: Set kV, CT Phantom type (head/body), Collimation, Pitch and Tube rotation time. These values are computed by Ocean Next and a value for scan speed is produced in the corresponding column. This value should match the table speed indicated on the CT console. If it doesn't, one or more of the set values on the CT Scanner console or Ocean Next template are incorrect and need to be adjusted.

When the values match, the measurement can be made.

Start the exposure taking into account any delay in the CT process.

Start the measurement in Ocean Next by clicking on the start button (see below). This must be done before the CT Scanner starts emitting radiation (i.e. before table starts moving).

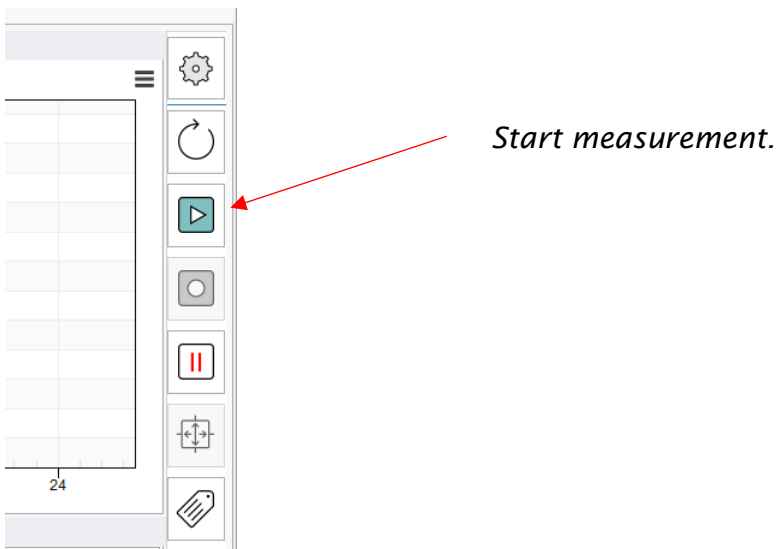

The measurement is in Timed mode and will stop after 10s (measuring time).

When the measurement is done, a waveform like the one below should appear and values for $CTDI_{100}$, $CTDI_w$ and $CTDI_{vol}$ should be shown.

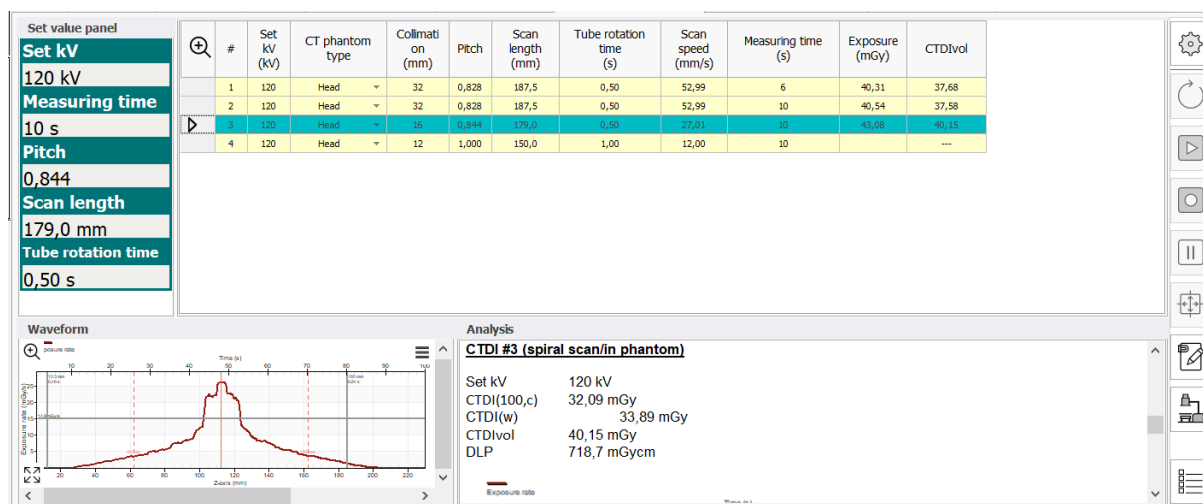

The uneven shape of the dose rate waveform is due to the attenuation occurring as the tube moves under the couch.

2.7.2.2 Measuring CT Beam Width with the RTI CT Dose Profiler

The procedure for measuring CT Beam Width (FWHM) is similar to CTDI measurement. The difference being that the CT Dose Profiler is pushed out of the CT phantom so that the point-dose detector is free-in-air, beyond the edge of the couch, but the cable-end remains in the center hole of the CT phantom.

The CT scanner should be set up for helical scan where the point-dose detector travels through the whole CT beam.

The Ocean Next template to select is Dose Profile (or Geometric Efficiency).

Phantom type should be set to Free-in-air.

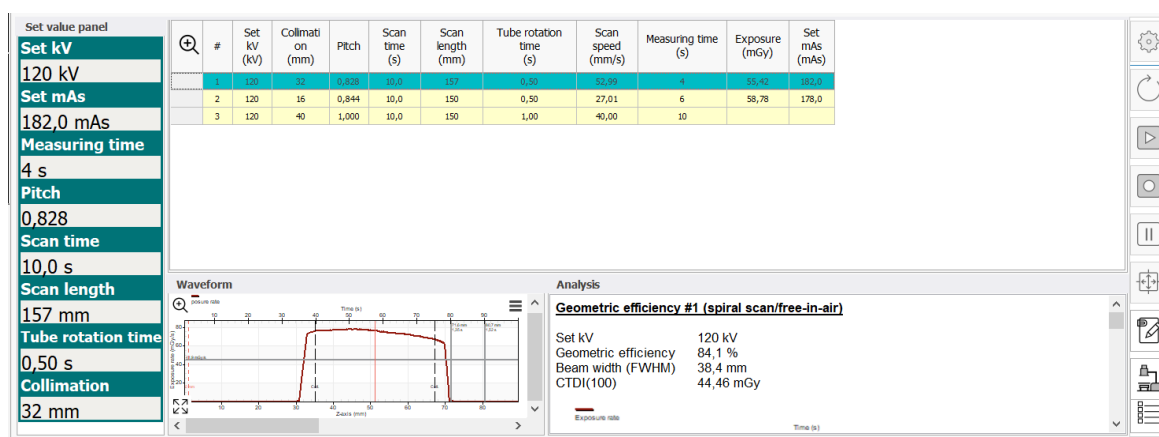

2.7.2.3 Measuring point dose with the RTI CT Dose Profiler

Starting Quick Check with the CT Dose Profiler and Legacy Module connected the following screen will be shown.

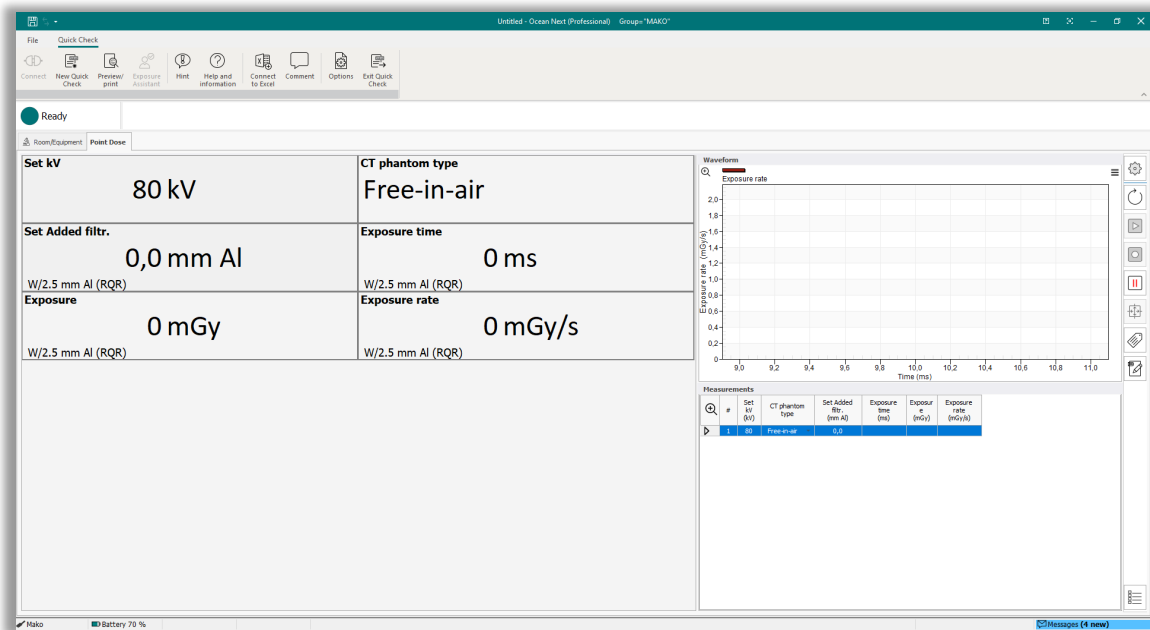

Make an exposure. Measurement data for the latest exposure will be shown in the displays.

The window to the upper right will show the waveform of dose rate for the latest exposure.

To the lower right is a grid showing the measurement data for each exposure, row by row.

Change unit of measure by right-clicking on the unit of measure in the display and select a new unit of measure.

2.7.3 Measuring with the RTI Dose Probe

With the RTI Dose Probe and the Legacy Module connected on their own, the following display configuration will appear.

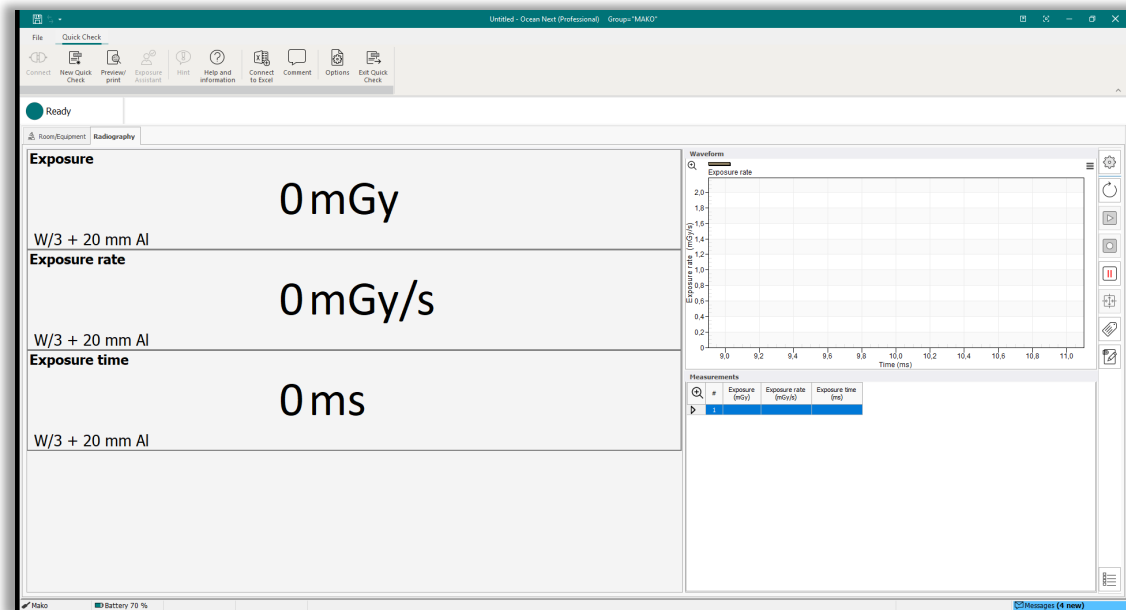

Here the user has the possibility to measure the dose, dose rate and exposure time.

Position the RTI Dose Probe ensuring that the whole active area is irradiated. The active area is marked with a white square (100 mm²).

Make an exposure. Measurement data for the latest exposure will be shown in the displays.

The window to the upper right will show the waveforms of dose rate for the latest exposure.

To the lower right is a grid showing the measurement data for each exposure, row by row.

Change unit of measure by right-clicking on the unit of measure in the display and select a new unit of measure.

If the RTI Dose Probe and Legacy Module are connected in parallel with the R/F Probe or the Mammo Probe the following pop-up will appear, given the user the choice of measurement configuration.

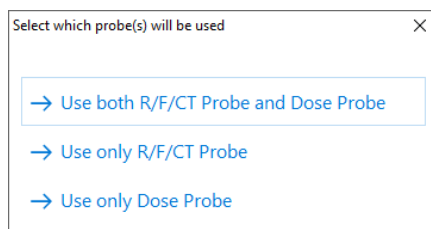

If “use only external probe” is selected, the display configuration above will appear, showing only dose, dose rate and exposure time.

If selecting “both external and internal probe” is made a pop-up screen will appear with the choice of modality.

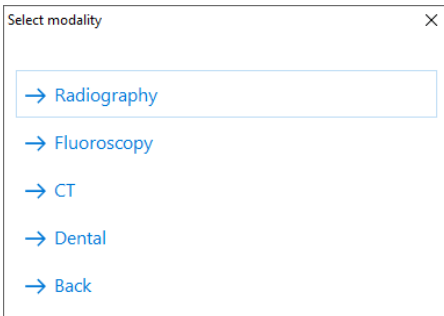

If Radiography is selected the following screen will appear showing measurement data from the probe (R/F or Mammo), kV, exposure time, dose, dose rate, HVL and Total Filtration. If Fluoroscopy is selected additional screens will appear showing mAs per frame as well as frame rate, number of frames and dose per frame.

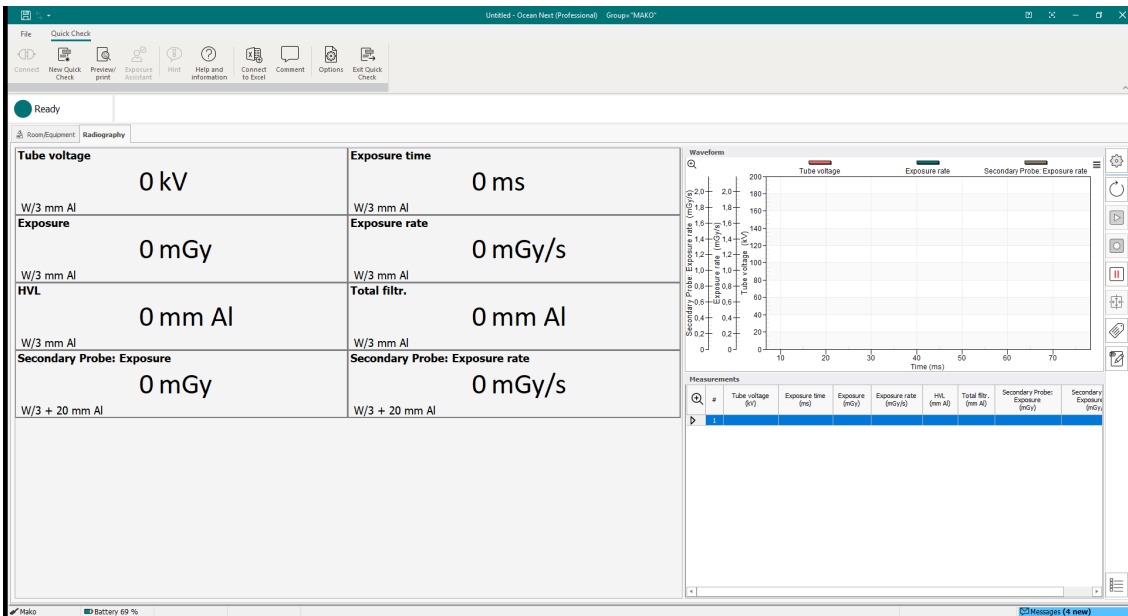

Measurement data from the RTI Dose Probe will appear in the displays at the bottom of the display area, labeled Secondary Probe.

Make an exposure. Measurement data for the latest exposure will be shown in the displays.

The window to the upper right will show the waveforms of kV, dose rate from the probe and dose rate from the RTI Dose Probe.

To the lower right is a grid showing the measurement data for each exposure, row by row.

Change unit of measure by right-clicking on the unit of measure in the display and select a new unit of measure.

2.7.4 Measuring with the RTI T20

RTI T20 is a derivative of the RTI Dose Probe, with a smaller active area (20 mm²) and radiographic footprint making it suitable for dose measurement in Fluoro applications or others where AEC is active.

The procedure for measuring with the RTI T20 is identical to that of RTI Dose Probe above.

2.7.5 Measuring with the RTI MAS-1

Using the MAS-1 probe with the Mako Legacy Module is virtually identical to the procedure for measuring mA and mAs with the Mako mAs Module.

Please refer to section [Measuring mA and mAs](#)

2.7.6 Measuring with the RTI MAS-2

Using the MAS-2 probe with the Mako Legacy Module is virtually identical to the procedure for measuring with the MAS-2 probe and the Mako mAs module.

Please refer to section [Measuring mA and mAs](#)

2.7.7 Measuring with the RTI Test Point Cable

Using the RTI Test Point Cable with the Mako Legacy Module is virtually identical to the procedure for using the Mako Test Point Cable with the Mako mAs Module.

Please refer to section [Measuring mA and mAs](#)

2.7.8 Settings for the Legacy Module

For more information about settings for the Legacy Module, please see section [Meter Settings](#)

2.8 Meter Settings

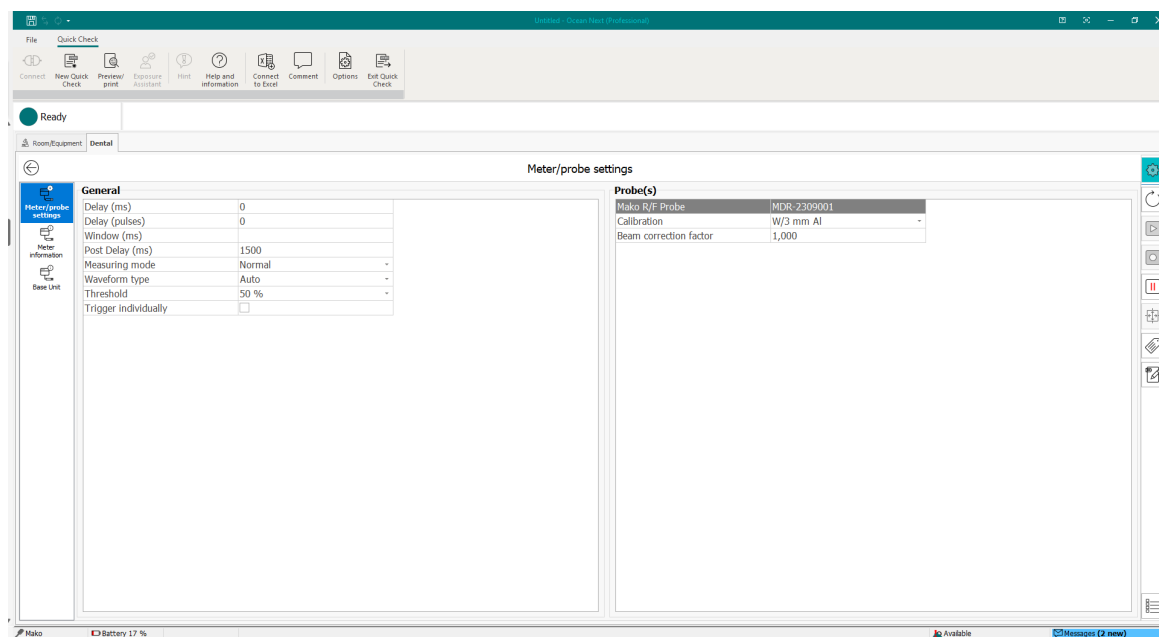

2.8.1 General Settings (probe Settings explained below, for each probe type)

- **Delay (ms)**
The delay time defines how long time the Mako shall wait before starting to measure kVp after that radiation has been detected.
- **Delay (pulses)**
- **Window (ms)**
This gives the possibility to define a fixed time that Mako measures kVp after that the delay time has expired.
- **Post Delay (ms)**
The post delay time defines how long time the Mako shall wait and "look for



more" after detecting what can be considered to be "the end of the exposure". Default value is 250 ms. The post-delay is necessary when measuring on units with some kind of pre-pulse or for pulsed exposures.

- **Measuring mode**

Three different alternatives are available:

- Normal, the Mako will start measuring once radiation is above the trig level and continuously sends data as long as radiation is detected. Typically used for general measurements.
- Timed, the user sets a measurement time and starts the measurement manually. The Mako will measure all radiation received during the set measurement time.
- Free run, the user starts and stops the measurement manually thus letting the Mako continuously measure the radiation without any trig levels.

- **Waveform type**

- Auto covers all generator types except AMX-4
- AMX-4 uses an algorithm specially designed to measure kV in the unique high-frequency-ripple spectrum generated by the AMX-4 from GE.

- **Threshold**

This defines the level (% of max level) at which exposure time measurement starts and stops. Default is 50% of max dose rate level.

- **Trigger Individually**

Normally, when more than one probe/module is connected, the measurement is triggered by the R/F, Mammo or Dental Probe. If the option "Trigger individually" is selected, the measurements from the separate sources will be triggered separately.

2.8.2 Probe Settings

2.8.2.1 Settings for R/F Probe

- **Calibration**

Indicates what calibration is in use by the system.

- **Beam Correction factor**

Allows the user to apply a correction factor, e.g. a backscatter factor so that the measurement aligns with the measurement of an ion chamber that is affected by backscatter unlike the Mako Probes.

2.8.2.2 Settings for Mammo Probe

- **Calibration**

Indicates what calibration is in use by the system.

- **Beam Correction factor**

Allows the user to apply a correction factor, e.g. a backscatter factor so that the measurement aligns with the measurement of an ion chamber that is affected by backscatter unlike the Mako Probes.

2.8.2.3 Settings for Dental Probe

- **Calibration**

Indicates what calibration is in use by the system.

- **Beam Correction factor**

Allows the user to apply a correction factor, e.g. a backscatter factor so that the

measurement aligns with the measurement of an ion chamber that is affected by backscatter unlike the Mako Probes.

2.8.2.4 Settings for mAs Module

- *Auto Adjust: Apart from General Settings, no further settings are required.*

2.8.2.5 Settings for Ion Chamber Module

- *Calibration*
Indicates what calibration is in use by the system.
- *Beam Correction factor*
Allows the user to apply a correction factor, e.g. a backscatter factor so that the measurement aligns with the measurement of an ion chamber that is affected by backscatter unlike the Mako Probes.
- *Temperature*
Shows the temperature recorded by the PID attached to the Ion Chamber.
- *Pressure*
Shows the air pressure recorded by the PID attached to the Ion Chamber.

2.8.2.6 Settings for Legacy Module

- *Calibration*
Indicates what calibration is in use by the system.
- *Compression Paddle used*
Is only active when an RTI Dose Probe is used in Mammography. To compensate dose measurements for the presence of a Compression Paddle in the beam.
- *Added Filtration*
Is only active when an RTI Dose Probe is used in Mammography.
- *Beam Correction factor*
Allows the user to apply a correction factor, e.g. a backscatter factor so that the measurement aligns with the measurement of an ion chamber that is affected by backscatter unlike the Mako Probes.



2.8.3 Meter/Probe information

Under Meter/probe information you can find relevant information regarding what calibrations have been loaded for the attached probe/module, calibration date, product version, hardware and firmware version.

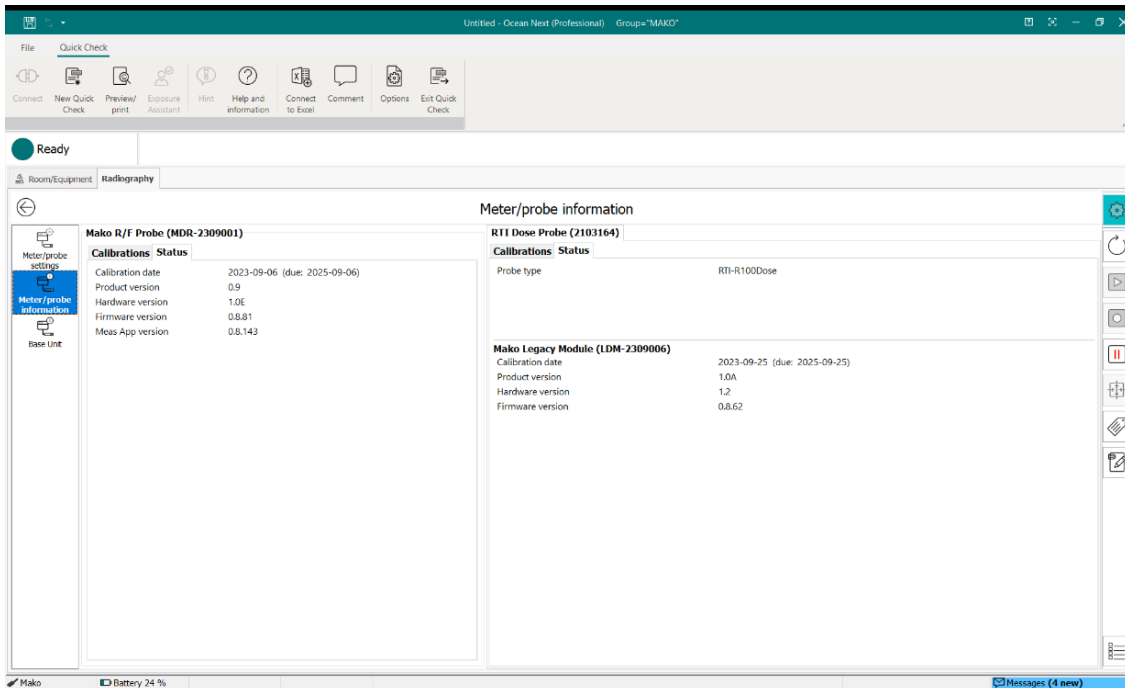
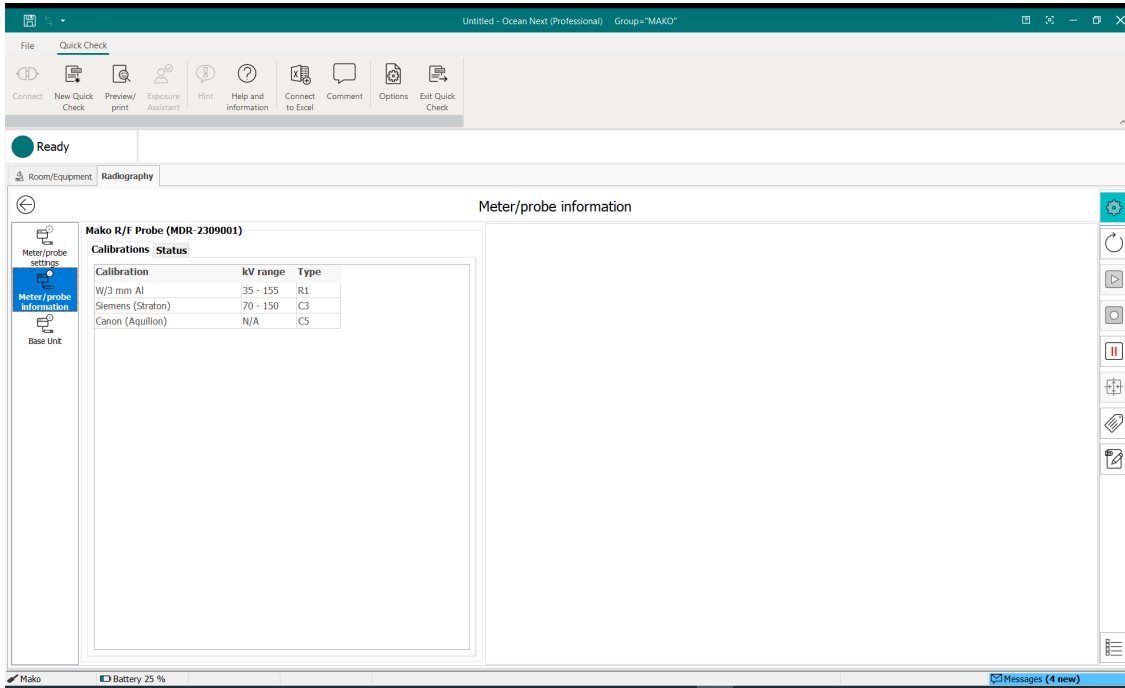

2.8.4 Base Unit information

Under Base Unit information, you find information regarding the Base Unit, like Product version, hardware and firmware and system versions as well as Ocean Next license level (Advantage or Professional).

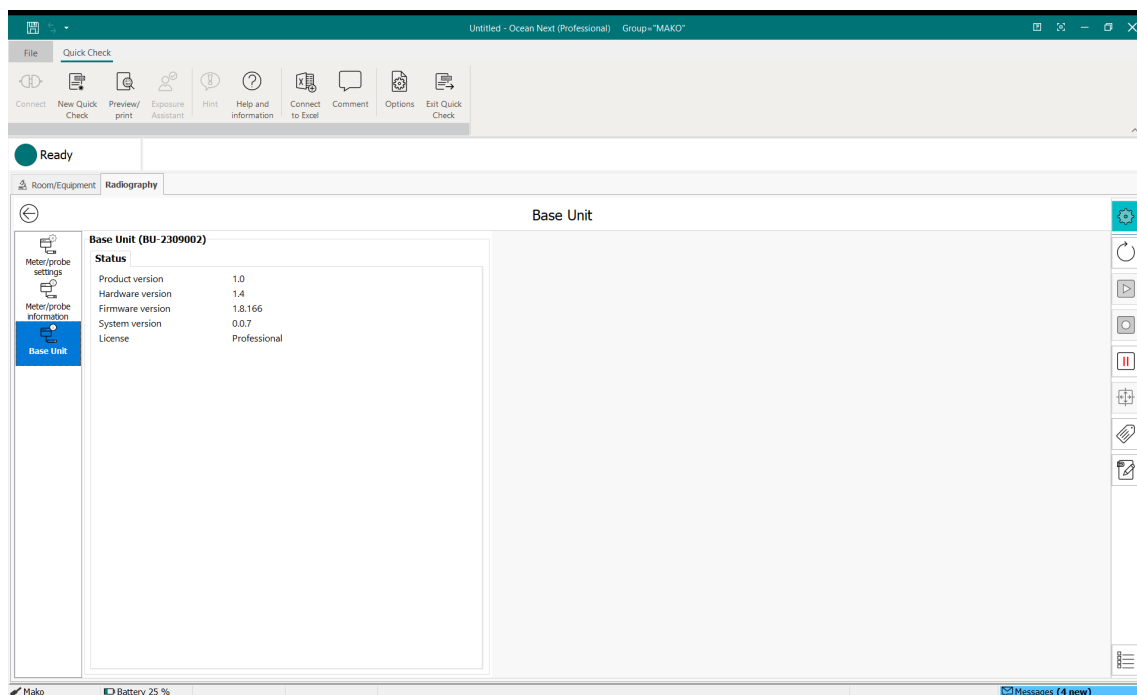

2.9 Measurement Principles & Theory

The Mako has a number of measurement algorithms and applications built in. This section describes some about the principles, how some values are calculated, and the basic use of such measurements.

2.9.1 Waveforms and Triggers

To get an understanding of how triggers, delays, and windows work, please see the waveform below. This is what happens during a standard radiation measurement:

1. *The radiation starts, i.e. it goes over the detector's lowest trig level.*
2. *The signal reaches 50 % of its maximum. This is the starting point for the irradiation time calculation. (The level is user adjustable.)*
3. *The Delay time is reached. (User adjustable.) kV integration window starts.*
4. *The signal reaches its maximum. The max value used for calculations is after Delay. This to ignore massive test peaks that some units give out.*
5. *The Delay+Window time is reached. (User adjustable.) kV integration window stops. For the default Window setting (infinite) this is normally at point 7.*
6. *The signal goes below 50 % of its maximum. This is the end point for the Irradiation time calculation. (The level is user adjustable.)*
7. *The radiation ends, i.e. it goes under the detector's lowest trig level.*

8. If the signal has been below the trig level during all of Post delay, the exposure is considered finished. All exposure readings are calculated and displayed.
9. If the signal has been below the trig level during all of Post delay and Restart delay, the exposure is considered permanently finished. All exposure readings are calculated and displayed.

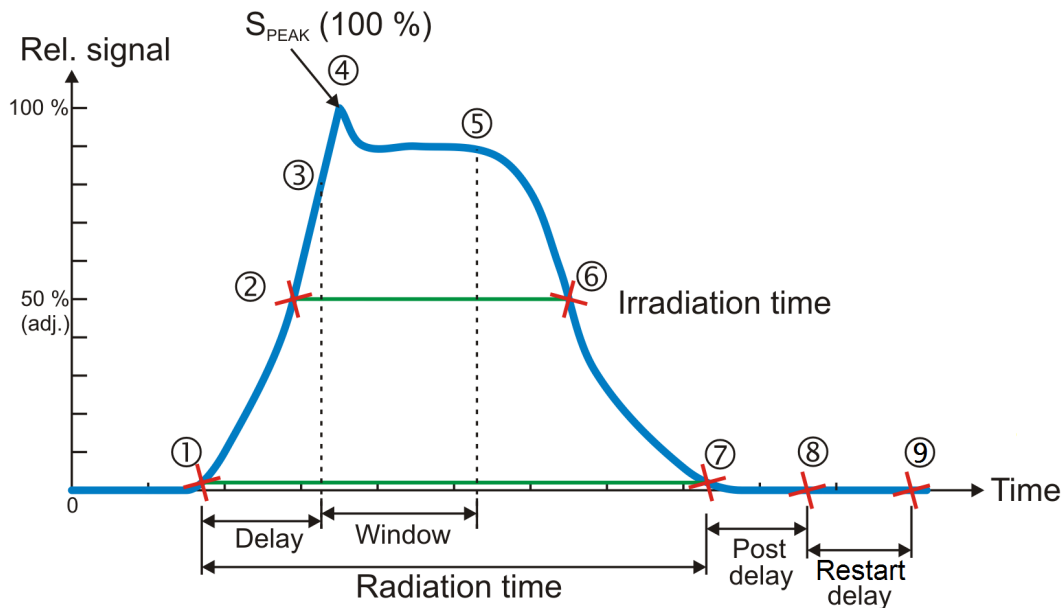

2.9.2 Integrated signal (dose, mAs, etc.)

Is the integration of all signal which means the area below the curve above from point 1 to 7. During the measurement (exposure) the accumulated signal (dose, etc) is displayed where applicable.

2.9.3 Signal rate (dose rate, tube current, etc.)

When a normal length measurement is over, point 8 above, the mean signal for the whole measurement (except delay time) is displayed. This signal rate is calculated as all integrated signal after delay (from point 3 to 7 as described above) divided by the time from point 3 to 6.

When the measurement continues for more than two seconds, typically for fluoroscopy, the mean signal for the last two seconds is displayed every two seconds. When the measurement is over, the value from the second last update is displayed, to avoid trig off ramp effects in the last two seconds.

2.9.4 Tube voltage signal (kV, kVp)

The Mako measures two "different" tube voltages.

1. The integrated tube voltage (unit kV). This value corresponds to the standardized PPV method, which intends to give a value that independently of waveform gives the same image quality and dose contrast for a standardized phantom. This value corresponds to a summation of the waveform samples between 3 and 4 in the pictures below. This value can "always" be calculated.

2. The peak tube voltage (unit kVp). This value corresponds to the technical peak voltage from the generator output, not at all representative of the resulting image aspects. Here only the top waveform values (over a certain percentage of the peak level) is included (out of the waveform samples between 3 and 4 in the pictures below). This value is thus much more sensitive to waveform noise, which means that at low signal, only kV can be given. In that case increase the output or shorten the distance to get a kVp reading.

The second method disregards the samples during delay, to avoid overshoot or other regulating effects from the generator. The first method is not so sensitive to these effects.

As seen in the example pictures below, for a DC/HF generator with little HV waveform ripple, the values are the same, but for units with HV ripple they diverge. Note also that if the DC/HF output is pulsed, the kV and kVp is normally still the same.

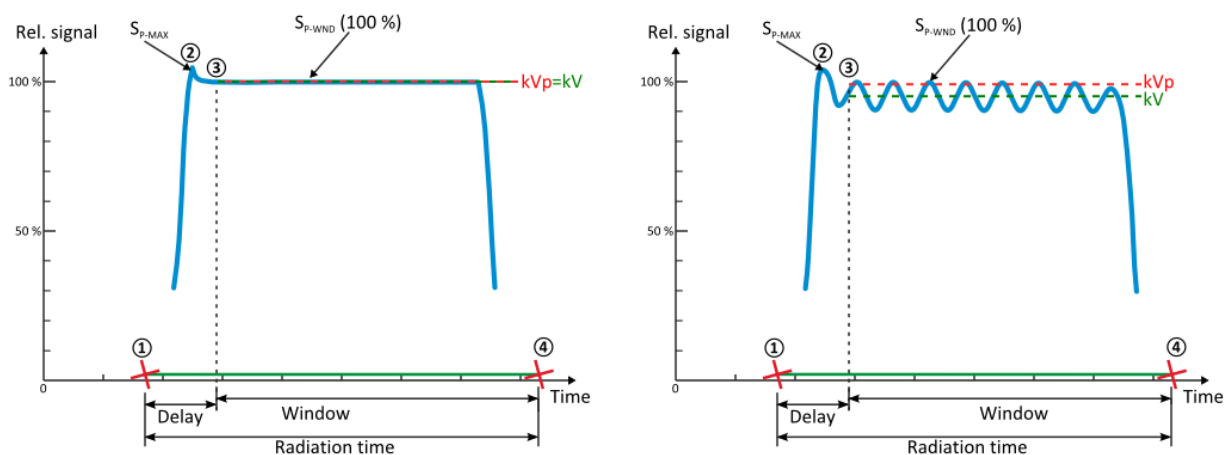

2.9.5 Measurement Principle for the Mako

The Mako detector packages consist of several electrometer channels connected to the layered diodes with varying radiation filters. Using different combinations of these signals the Mako can accurately measure the dose, tube voltage, total filtration and HVL for the full radiological imaging range. Since all signals are captured simultaneously and with a high speed, the Mako can automatically compensate the kV and dose for the dependence of the waveform and inherent/added tube filtration.

3. The Quick Check Display

3.1 Measurement Displays

Depending on the modality and probe/module selection made when starting Quick Check, different configurations of displays will appear. These displays will show measurement data from the latest exposure. Left-click on the heading of a display (e.g. "Tube voltage") to enlarge it.

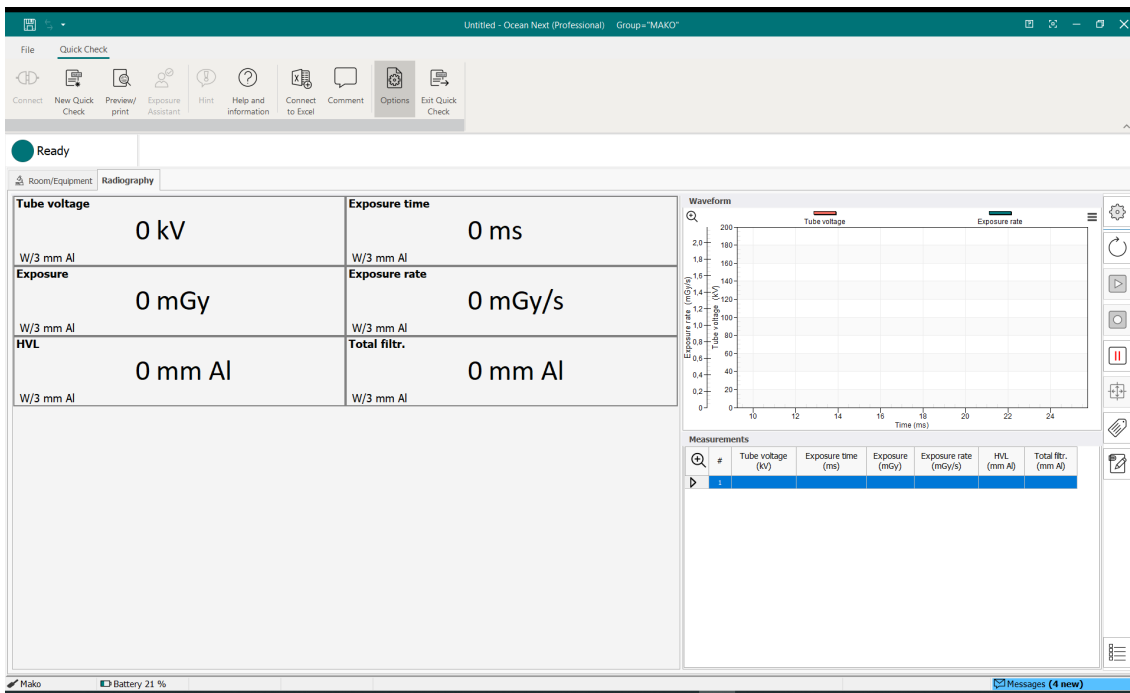

Tube voltage	Exposure time
43,05 kV	1600 ms
W/0.70 mm Al	W/0.70 mm Al
Exposure	Exposure rate
1177 μ Gy	0,7354 mGy/s
W/0.70 mm Al	W/0.70 mm Al
HVL	
1,85 mm Al	
W/0.70 mm Al	

3.1.1 Changing unit of measure

To change unit of measure, hover over the unit of measure in a display and right-click. Select a new unit of measure from the pop-up menu.

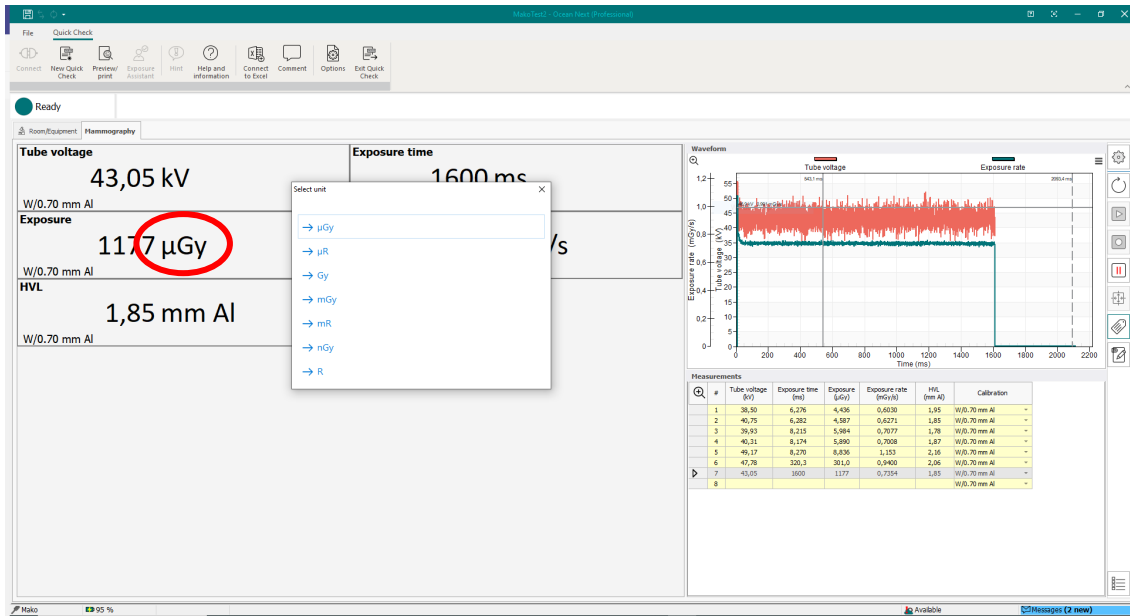

Note that this change also affects the unit of measure of the corresponding column in the grid.

3.1.2 Changing Beam Quality/Calibration

To change Beam Quality/Calibration, hover over the beam quality in a display and right-click. Select a new beam quality from the pop-up menu.

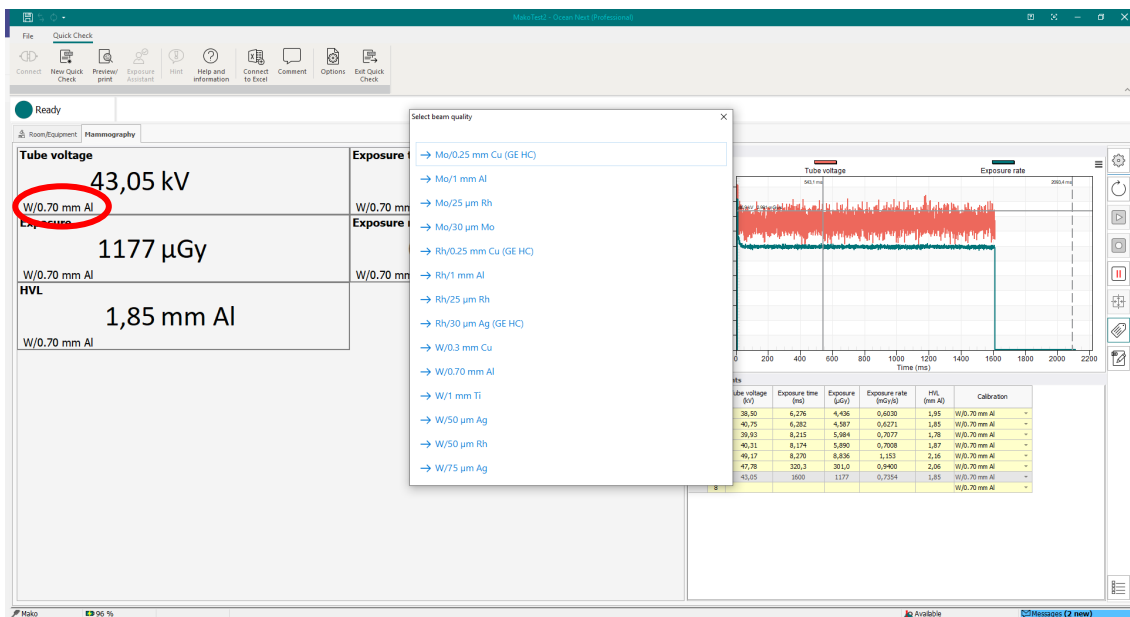

Note that this change also affects the column "Calibration" in the grid.

3.2 Waveform window

The waveform window shows the waveform of relevant signals (e.g. kV, dose rate, mA) for the exposure highlighted in the grid. Note that there may be separate scales on the y-axis for the different signals.

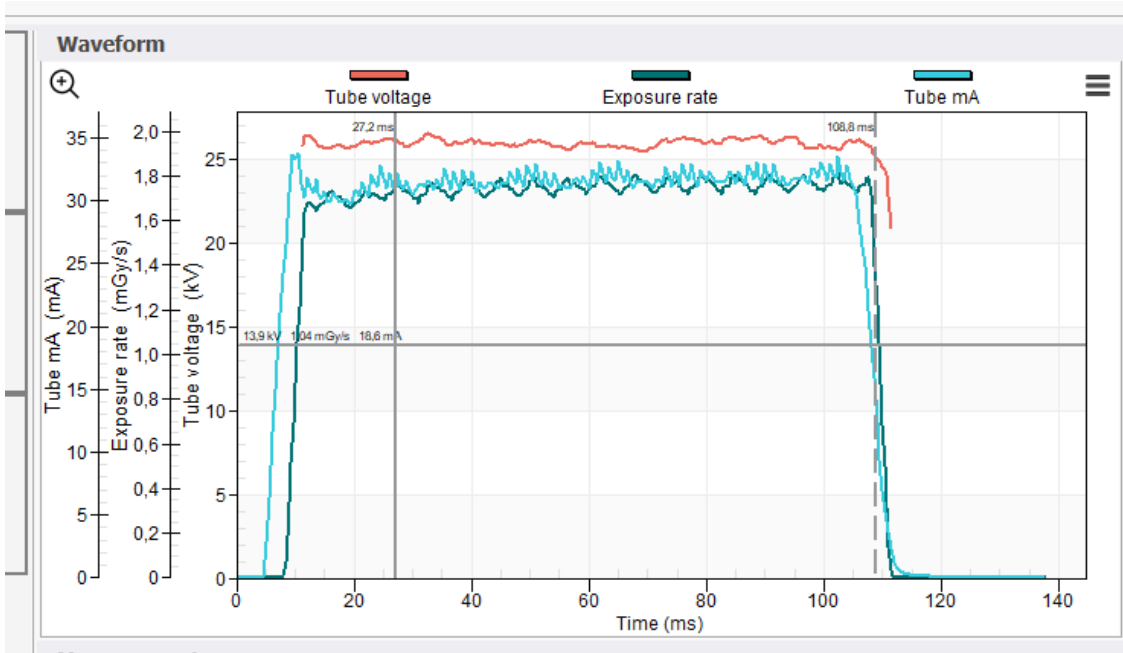

3.2.1 Analyzing waveforms

The waveforms can be analyzed by zooming in. Click-and-drag to mark an area of interest.

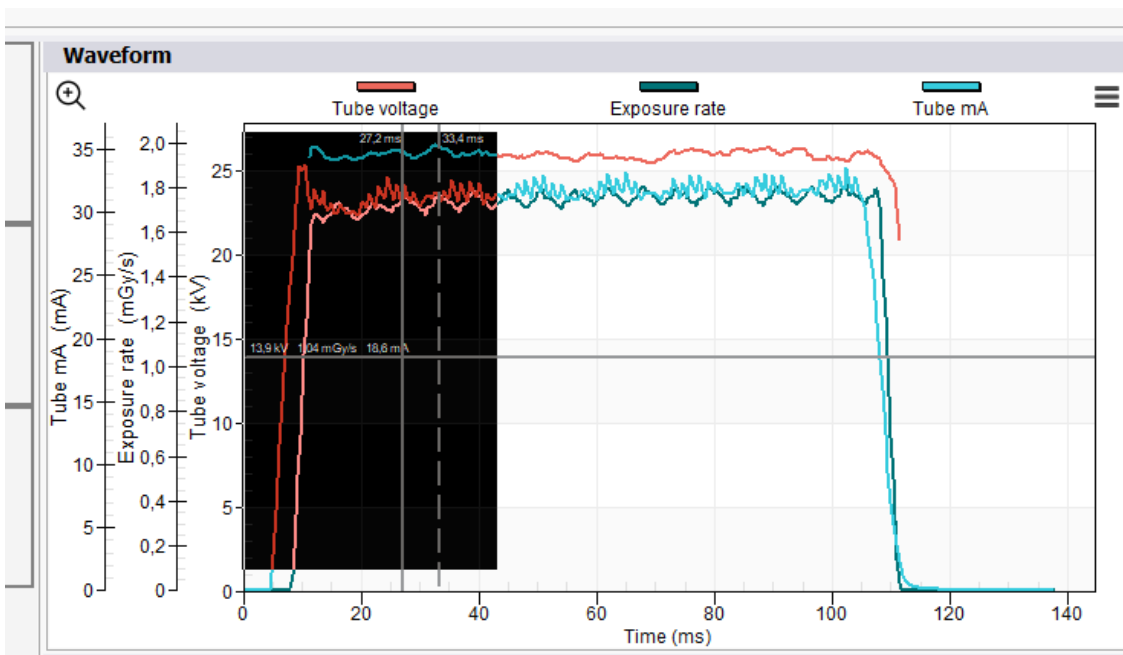

This area will be expanded for a closer look at the waveform.

To get more information and to move cursors, click on the magnifying glass symbol in the top left corner.

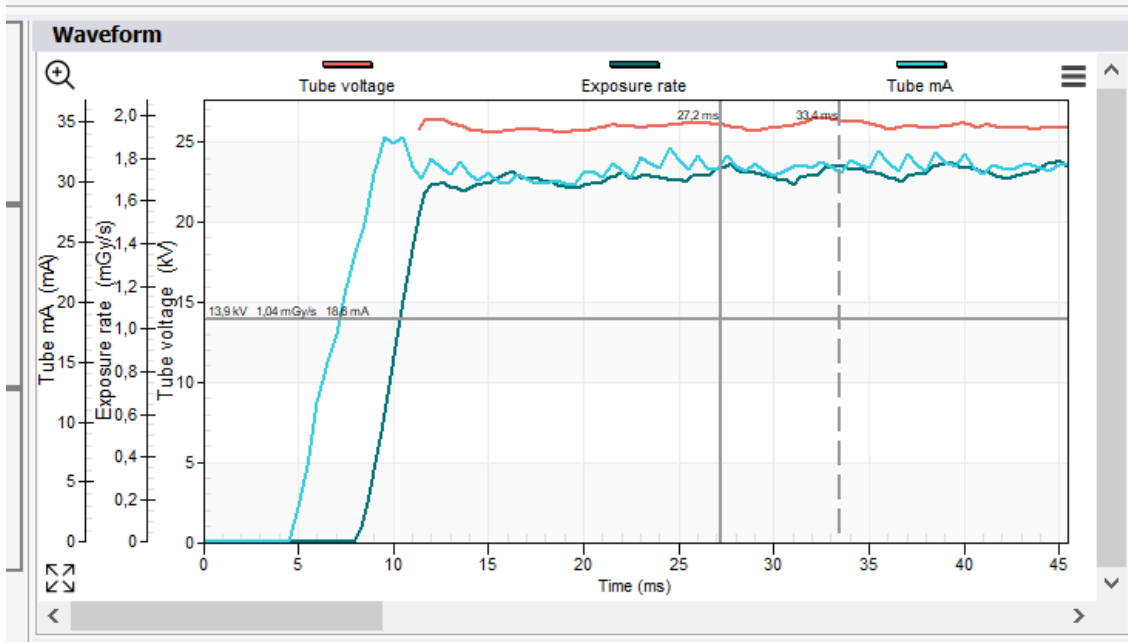

This will reveal a table of values referring to the position of the cursors as well as difference in measurements e.g. time diff between cursor positions.

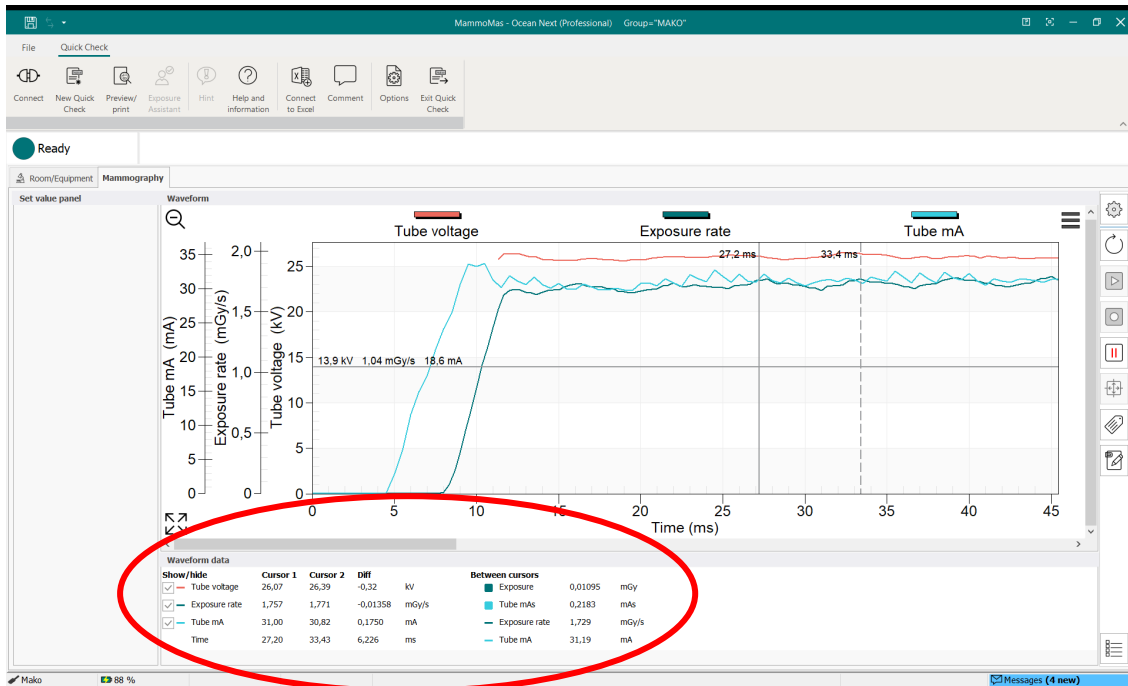

3.3 Measurement grid

The measurement grid shows a list of measurement data in sequence. To overwrite an exposure, left-click in the grey area to the left of the row (the row is highlighted) and repeat the exposure. New data will overwrite the old.

Measurements							
#	Tube voltage (kV)	Exposure time (ms)	Exposure (μ Gy)	Exposure rate (mGy/s)	HVL (mm Al)	Calibration	
1	38,50	6,276	4,436	0,6030	1,95	W/0.70 mm Al	
2	40,75	6,282	4,587	0,6271	1,85	W/0.70 mm Al	
3	39,93	8,215	5,984	0,7077	1,78	W/0.70 mm Al	
4	40,31	8,174	5,890	0,7008	1,87	W/0.70 mm Al	
5	49,17	8,270	8,836	1,153	2,16	W/0.70 mm Al	
6	47,78	320,3	301,0	0,9400	2,06	W/0.70 mm Al	
7	43,05	1600	1177	0,7354	1,85	W/0.70 mm Al	
8						W/0.70 mm Al	

3.4 Quick Check Report

A simple report can be generated for the measurement session by clicking on the "Preview/print" button on the top ribbon.

Tube voltage 0 kV
Mo/30 μ m Mo
Exposure 0 mGy
Mo/30 μ m Mo
HVL 0 mm Al
Mo/30 μ m Mo
Tube mA 0 mA
mA, mAs

Exposure time 0 ms
Mo/30 μ m Mo
Exposure rate 0 mGy/s
Mo/30 μ m Mo
Tube mAs 0 mAs
mA, mAs

Waveform

Tube mA (mA)
Tube voltage (kV)
Exposure rate (mGy/s)
Time (ms)

Measurements

#	Tube voltage (kV)	Exposure time (ms)	Exposure (mGy)	Exposure rate (mGy/s)	HVL (mm Al)	Tube mAs (mAs)	Tube mA (mA)
1	28,18	99,54	0,2477	3,487	0,238	4,989	49,65
2	25,88	99,49	0,1738	1,748	0,243	3,228	32,08
3							

To save a PDF file of the report, click the Acrobat symbol.

MammoMas

ocean

Mammography

Measurements

#	Tube voltage (kV)	Exposure time (ms)	Exposure (mGy)	Exposure rate (mGy/s)	HVL (mm Al)	Tube mAs (mAs)	Tube mA (mA)	Calibration
1	28,18	99,54	0,3477	3,497	0,358	4,989	49,65	Mo/30 µm Mo
2	25,88	99,49	0,1738	1,748	0,343	3,228	32,08	Mo/30 µm Mo

Test equipment used

Meter(s): Mako Mammo Probe S/N MDM-2309001
 Probe(s): CobiaMAS S/N NA (Mako mAs Module S/N NA)

Page 1 of 1

Waveforms can be added to the report by highlighting the corresponding row in the grid then clicking on the hamburger symbol then selecting “Include waveform in report”.

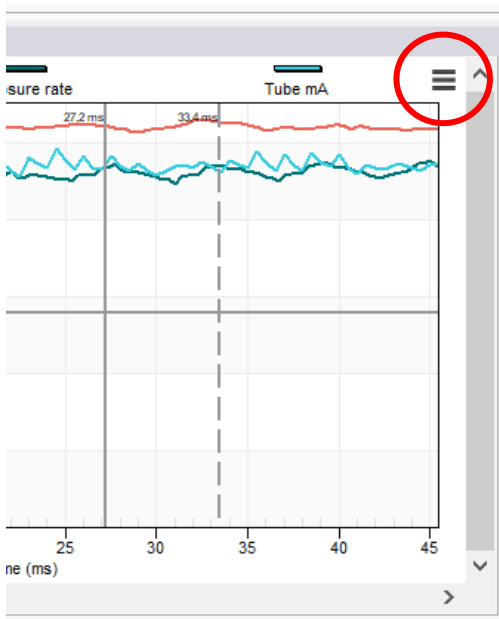



3.5 Quick Check Options

The options that affect Quick Check are found by clicking the Options button in the top ribbon.

There you have the option to bypass the modality selection at launch of Quick Check (useful e.g. if majority of work is done in Radiography, Quick Check can default to Radiography directly). Clicking the button New Quick Check will make it possible to select other modalities.

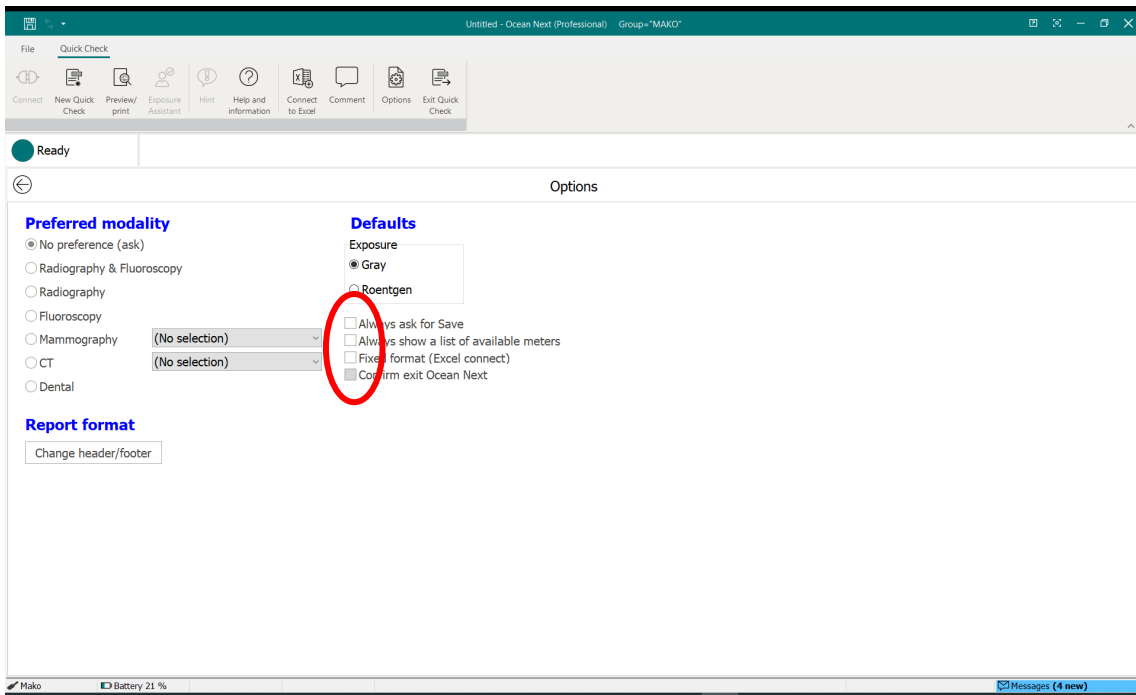

In order not to lose data, the user may consider ticking “Always ask for Save” and “Confirm exit Ocean Next” which will force a confirmation from the user before closing Quick Check or Ocean Next which may reduce the risk of unnecessarily losing measurement data.

Modification to the report format, e.g. use a different logotype, can be made by clicking the button “Change report format”.

More options can be modified from the Home Screen Options menu.

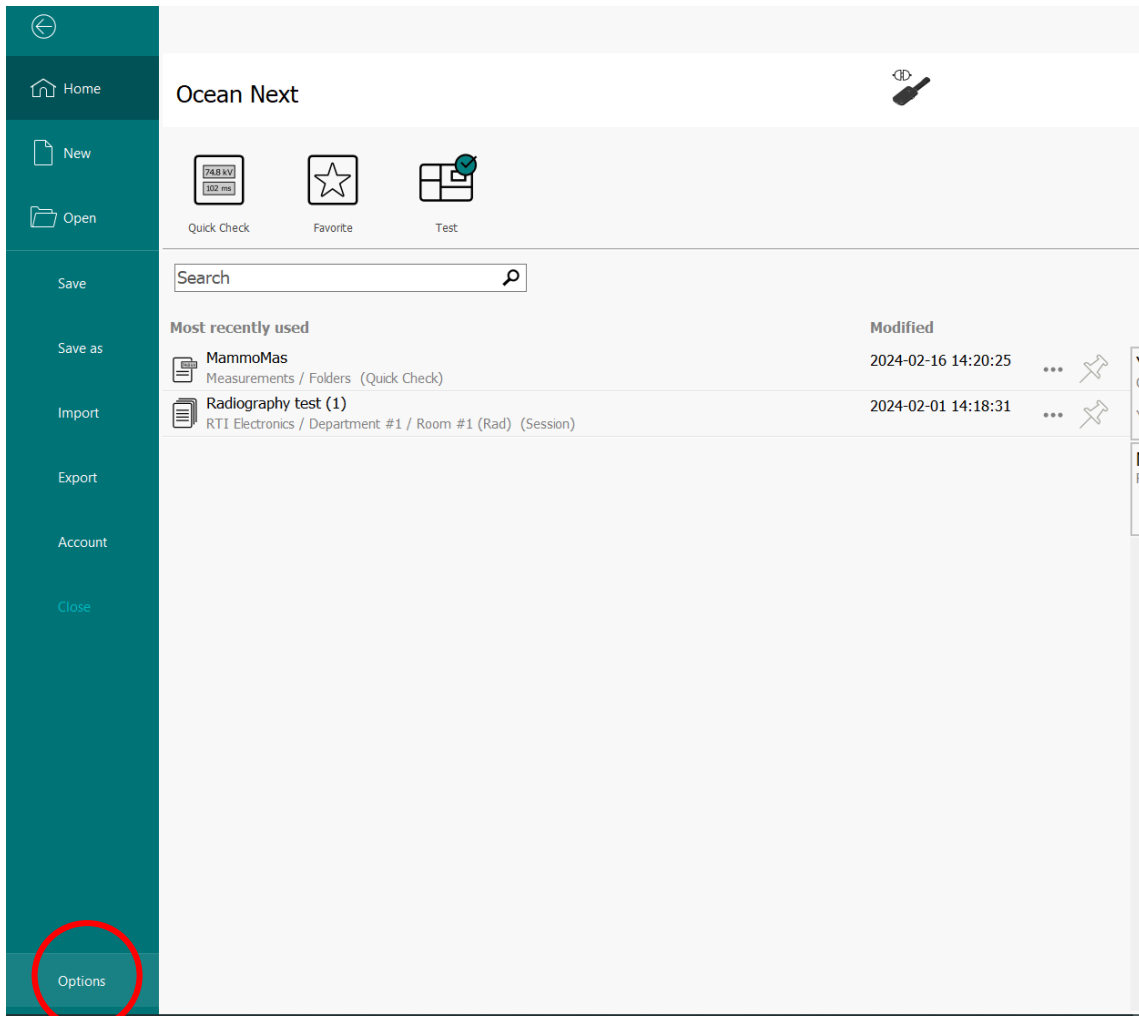

Home

Ocean Next

New

Open

Quick Check

Favorite

Test

Save

Search

Most recently used

	Modified	
MammoMas Measurements / Folders (Quick Check)	2024-02-16 14:20:25	... [Pin]
Radiography test (1) RTI Electronics / Department #1 / Room #1 (Rad) (Session)	2024-02-01 14:18:31	... [Pin]

Options

4. Updating the Mako system

As and when there are new updates available for the Mako firmware, the user will be notified, and an update zip-file should be downloaded from the RTI website. To perform the firmware update the user should go to the Account tab of the Home Screen, click the Tools button and select “Update Mako firmware”.

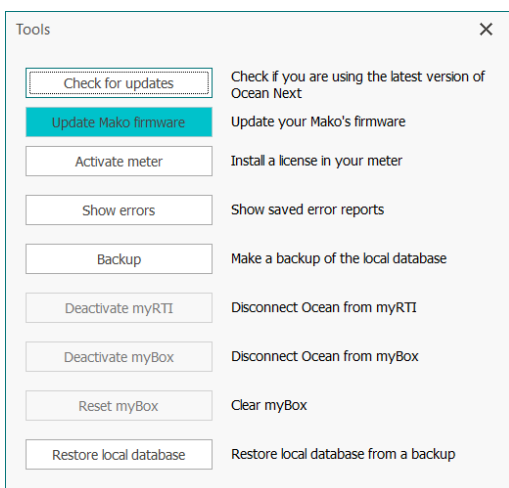
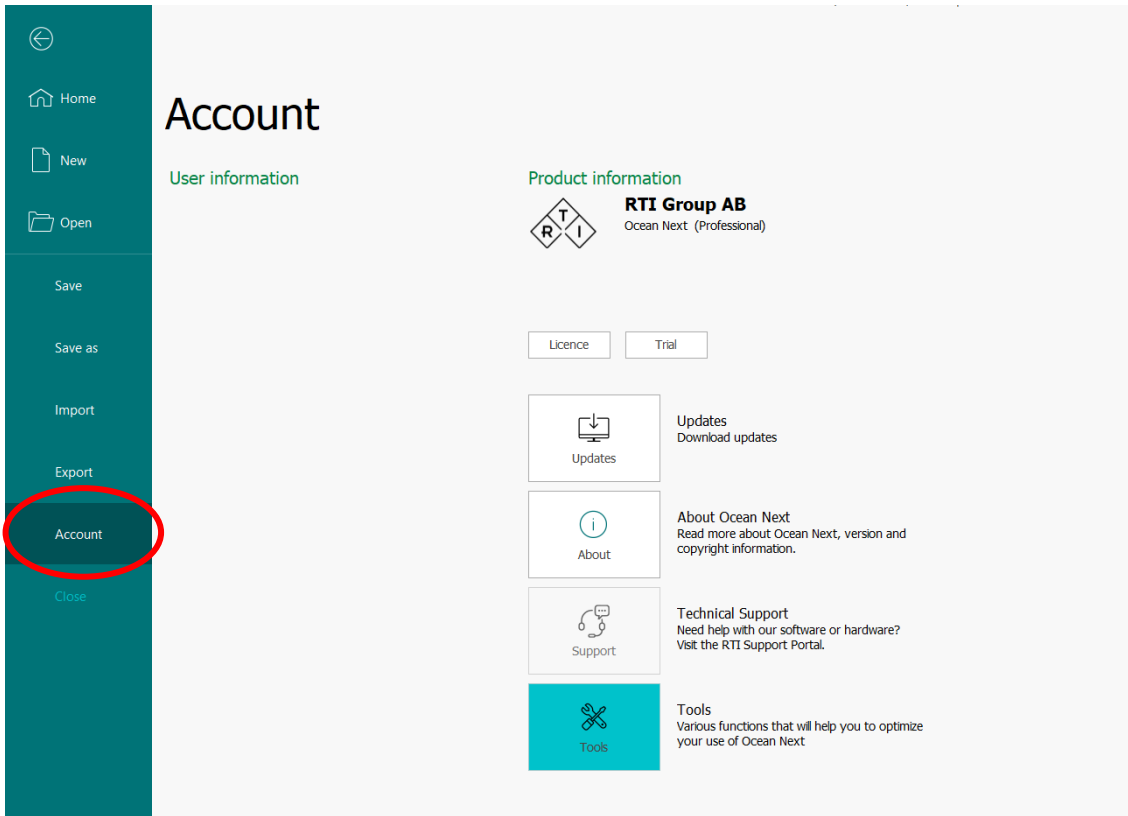

Follow the instructions, indicating the location of the downloaded zip-file.

Ensure that the Mako Base Unit is connected with a USB cable. The update package will be transferred to the Mako Base Unit. Once that transfer is completed, the Base Unit will be updated. Connect Probes and Modules to complete the firmware update of them as well.

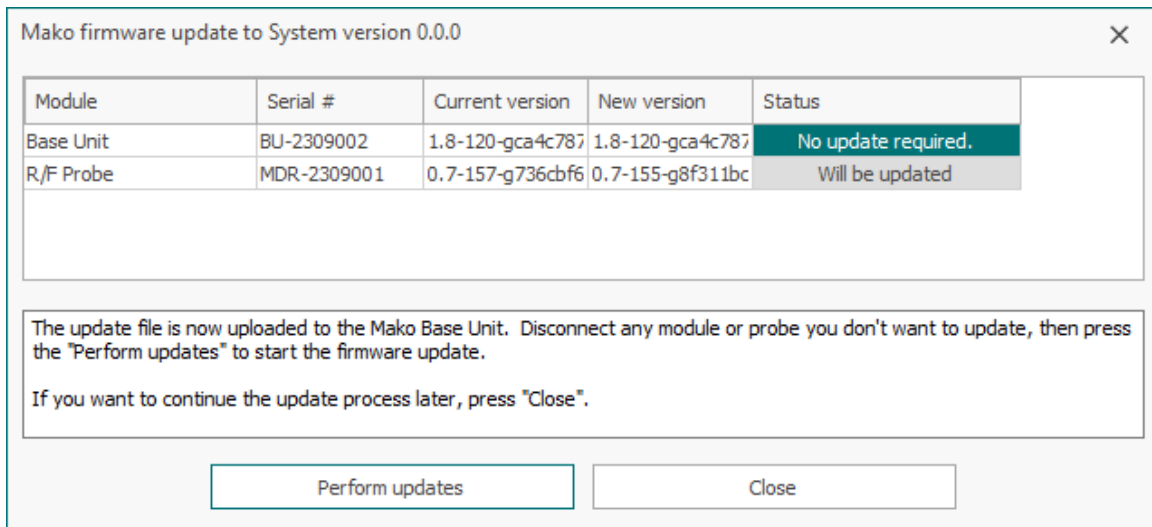

5. Charging the Base Unit

A low battery warning will be displayed when battery charge level is approaching low level.

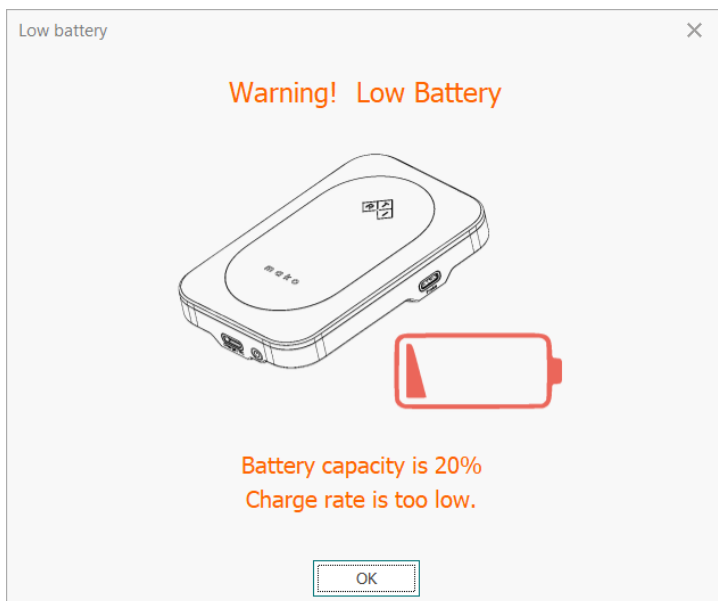

Connect the Base Unit charging port (marked Charge/PC) to the supplied charger or a PC using the supplied USB A - USB C cable.

6. Scheduled Calibration

RTI recommends that the Mako is calibrated every 24 months. Send your Mako to your local RTI distributor, who will send it to our service center in Mölndal, Sweden, or New Jersey, USA. For contact details, please see page 3, or the list of local RTI distributors on the RTI website.

7. The Mako Stand

The Mako stand can be used in many different setups. The arm can be raised/lowered and extended to place a probe in the desired position. Below are some examples.

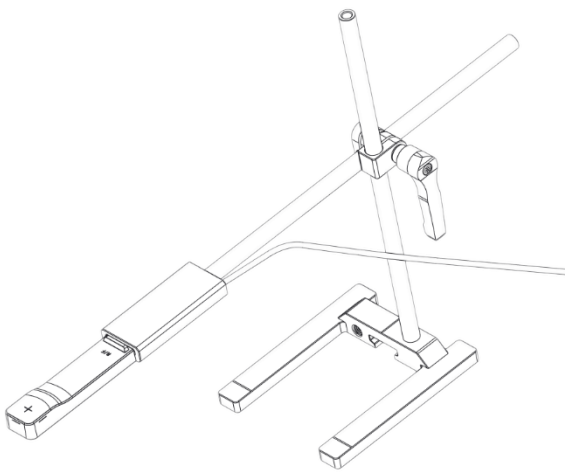

Positioning of Probe

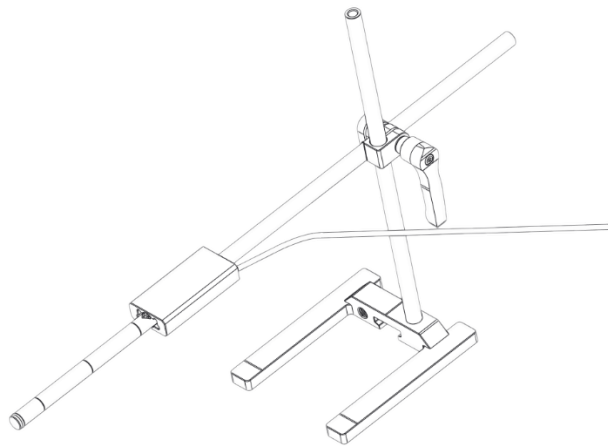

Measuring w CT Ion Chamber free-in-air

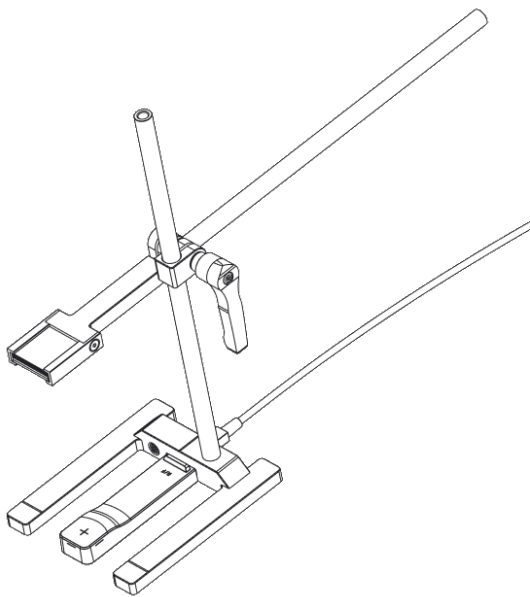

HVL filter holder

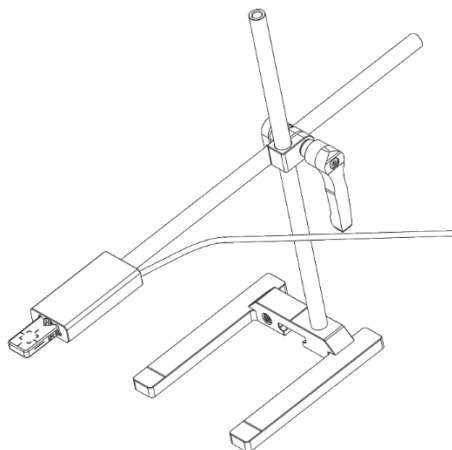

RTI Dose Probe positioning

8. *Manufacturer's Declaration of Conformity*

In the following section you can find declarations of conformity, as well as documents describing the intended use of the RTI Mako system.

8.1 CE Declaration of Conformity



Declaration of Conformity

We, RTI Group AB, Flöjelbergsgatan 8C, SE-431 37 MÖLNDAL, Sweden, declare under our sole responsibility that the product:

Product name:	Mako
Models and accessories:	According to Appendix 1
Type of equipment:	kV- & Electrometer
Intended use of this product:	According to Appendix 2

is in conformity with the provisions of the following EC Directive(s):

- 2014/30/EU Electromagnetic Compatibility (EMC) Directive
- 2014/35/EU Low Voltage Directive (LVD)
- 2015/863/EU Restriction of Hazardous Substances in EEE Directive (RoHS 3)

and that the following standards and/or technical specifications referenced below have been applied:

EN 55032/B, EN 55014, EN55035, EN 61000-3-2,
EN 61000-3-3, EN 61000-4-2, EN 61000-4-3, EN 61000-4-4,
EN 61000-4-5, EN 61000-4-6, EN 61000-4-11,
EN 62368-1 + AC1:2015, ETS 300 342-1



Möln dal, 2024-01-24



.....
Elin Sahlberg, CEO



Declaration of Conformity - Appendix 1

Mako system modules

Base Unit,	BU-2309001 and beyond
R/F Probe,	MDR-2309001 and beyond
Mammo Probe,	MDM-2309001 and beyond
Dental Probe,	MDD-2309001 and beyond
mAs Module,	IMM-2309001 and beyond
Ion Chamber Module,	ICM-2309001 and beyond
Legacy Module,	LDM-2309001 and beyond

Accessories

<i>Probe's name</i>	<i>Notice</i>
RTI Dose Probe	s/n: 1403099 and above
RTI T20, Dose Probe	
RTI Light Probe	
RTI MAS-1	product version 3.0
RTI MAS-2	
RTI CT Dose Profiler	product version 2.0
RTI CT Ion Chamber 10 cm	
RTI CT Ion Chamber 30 cm	
Ion Chamber Magna 1cc	
DAP Chamber 147x147 mm	
DAP Chamber 86x86 mm	
Mako mAs Cable	



Declaration of Conformity - Appendix 2

Intended use

Together with external probes, the Mako System is intended to be used for independent service and quality control, including measurements of kerma, kerma rate, kVp, tube current, half value layer (HVL), exposure time, luminance, illuminance, dose length product and dose area product, within limitations stated below.

When set up according to accompanying documents, the product is intended to be used together with any diagnostic X-ray equipment except for:

- therapeutical X-ray sources.
- X-ray equipment with tube potential below 18 kV or above 160 kV.
- X-ray equipment on which the instrument cannot be mounted properly.
- specific types of X-ray equipment listed in the instructions for use or in additional information from the manufacturer.

With the X-ray installation without the patient present, the product is intended to be used:

- for assessing the performance of the X-ray equipment.
- for evaluation of examination techniques and procedures.
- for service and maintenance of the X-ray equipment.
- for quality control of the X-ray equipment.
- for educational purposes, authority supervision etc.

The product is intended to be used by hospital physicists, X-ray engineers, manufacturer's service teams, and other professionals with similar tasks and competencies. The operator needs training to be able to use the product as intended. This training can be achieved either by study of the manual, study of the built-in help functions in measurement software or, on request, by a course ordered from the manufacturer.

The product is intended to be used inside X-ray rooms ready for clinical use and can safely be left switched on and in any measuring mode in the vicinity of patients.

The product is **NOT** intended to be used:

- for direct control of diagnostic X-ray equipment performance during irradiation of a patient.
- so that patients or other unqualified persons can change settings of operating parameters during, immediately before, or after measurements.
- for any guidance to diagnosis of patients.



8.2 UKCA Declaration of conformity



Declaration of Conformity

We, RTI Group AB, Flöjelbergsgatan 8C, SE-431 37 MÖLNDAL, Sweden, declare under our sole responsibility that the product:

Product name:	Mako
Models and accessories:	According to Appendix 1
Type of equipment:	kV- & Electrometer
Intended use of this product:	According to Appendix 2

is in conformity with the provisions of UKCA by conforming to the following EU Directive(s):

- 2014/30/EU Electromagnetic Compatibility (EMC) Directive
- 2014/35/EU Low Voltage Directive (LVD)
- 2015/863/EU Restriction of Hazardous Substances in EEE Directive (RoHS 3)

and that the following standards and/or technical specifications referenced below have been applied:

BS EN 55032/B, BS EN 55014, BS EN 55035, BS EN 61000-3-2,
BS EN 61000-3-3, BS EN 61000-4-2, BS EN 61000-4-3,
BS EN 61000-4-4, BS EN 61000-4-5, BS EN 61000-4-6,
BS EN 61000-4-11, BS EN 62368-1 + AC1:2015, ETS 300 342-1

**UK
CA**

Möln dal, 2024-01-24

.....
Elin Sahlberg, CEO



Declaration of Conformity - Appendix 1

Mako system modules

Base Unit,	BU-2309001 and beyond
R/F Probe,	MDR-2309001 and beyond
Mammo Probe,	MDM-2309001 and beyond
Dental Probe,	MDD-2309001 and beyond
mAs Module,	IMM-2309001 and beyond
Ion Chamber Module,	ICM-2309001 and beyond
Legacy Module,	LDM-2309001 and beyond

Accessories

<i>Probe's name</i>	<i>Notice</i>
RTI Dose Probe	s/n: 1403099 and above
RTI T20, Dose Probe	
RTI Light Probe	
RTI MAS-1	product version 3.0
RTI MAS-2	
RTI CT Dose Profiler	product version 2.0
RTI CT Ion Chamber 10 cm	
RTI CT Ion Chamber 30 cm	
Ion Chamber Magna 1cc	
DAP Chamber 147x147 mm	
DAP Chamber 86x86 mm	
Mako mAs Cable	



Declaration of Conformity - Appendix 2

Intended use

Together with external probes, the Mako System is intended to be used for independent service and quality control, including measurements of kerma, kerma rate, kVp, tube current, half value layer (HVL), exposure time, luminance, illuminance, dose length product and dose area product, within limitations stated below.

When set up according to accompanying documents, the product is intended to be used together with any diagnostic X-ray equipment except for:

- therapeutical X-ray sources.
- X-ray equipment with tube potential below 18 kV or above 160 kV.
- X-ray equipment on which the instrument cannot be mounted properly.
- specific types of X-ray equipment listed in the instructions for use or in additional information from the manufacturer.

With the X-ray installation without the patient present, the product is intended to be used:

- for assessing the performance of the X-ray equipment.
- for evaluation of examination techniques and procedures.
- for service and maintenance of the X-ray equipment.
- for quality control of the X-ray equipment.
- for educational purposes, authority supervision etc.

The product is intended to be used by hospital physicists, X-ray engineers, manufacturer's service teams, and other professionals with similar tasks and competencies. The operator needs training to be able to use the product as intended. This training can be achieved either by the study of the manual, a study of the built-in help functions in measurement software or, on request, by a course ordered from the manufacturer.

The product is intended to be used inside X-ray rooms ready for clinical use and can safely be left switched on and in any measuring mode in the vicinity of patients.

The product is **NOT** intended to be used:

- for direct control of diagnostic X-ray equipment performance during irradiation of a patient.
- so that patients or other unqualified persons can change settings of operating parameters during, immediately before, or after measurements.
- for any guidance to diagnosis of patients.

8.3 FCC Certification

*Supplier's Declaration of Conformity 47 CFR § 2.1077 Compliance Information
Responsible Party – U.S. Contact Information*

*RTI Group North America
33 Jacksonville Road, Building 1
Towaco, NJ 07082,
USA
+1 973-439-0242
support.us@rtigroup.com*

FCC Compliance Statement

This device complies with Part 15 of the FCC Rules. Operation is subject to the following two conditions: (1) This device may not cause harmful interference, and (2) this device must accept any interference received, including interference that may cause undesired operation.

8.4 Waste Electrical and Electronic Equipment (WEEE)

The European Union Directive 2002/96/EC on Waste from Electrical and Electronic Equipment (WEEE) places an obligation on manufacturers, distributors, and retailers to take back electronics products at the end of their useful life.

The WEEE directive covers all RTI products being sold into the European Union (EU) as of August 13, 2005. Manufacturers, distributors, and retailers are obliged to finance the cost of recovery from municipal collection points, reuse, and recycling of specified percentages per the WEEE requirements.

Instructions for disposal of WEEE by Users in the European Union

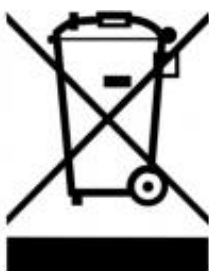

The symbol, shown left, is marked on the product, which indicates that this product must not be disposed of with other waste. Instead, it is the user's responsibility to dispose of the user's waste equipment by handing it over to a designated collection point for the recycling of waste electrical and electronic equipment. The separate collection and recycling of waste equipment at the time of disposal will help to conserve natural resources and ensure that it is recycled in a manner that protects human health and the environment.

For more information about where you can drop off your waste equipment for recycling, please contact your local distributor from whom you purchased the product.

